

BIZET - 370MF VW

370 - LED 500 W - VARIABLE WHITE



- **Type:** Single lens luminaire
- **Source:** LED 500 W - Variable White
- **Optics:** 200 mm Fresnel lens
- **Colour temperature:** 3000K --> 6300K
- **Focus:** Motorised - DMX control

Single lens

Full white spectrum Fresnel

The BIZET 370MF sets a new standard in LED Fresnel fixtures. Equipped with a powerful 500W variable white LED source, it delivers full output at any chosen colour temperature without compromise. This cutting-edge engine ensures high-quality white light across the spectrum, offering exceptional colour rendering and a beautifully smooth, even beam. This model is equipped with motorised focus to adjust beam size remotely. Compact and quiet, the BIZET 370MF combines precise control and robust construction. Ideal for theatre, broadcast, and live events, it brings versatility, reliability, and performance to any lighting environment.

Features

- **Colour Temperature (CCT):** adjustable whites from 3000 to 6300 Kelvin. Extended mode available (CCT not calibrated)
- **Motorised focus:** beam size remotely adjustable (by DMX) or locally with on-board keypad and display
- **Theatre front cassette:** no light spill to distract audiences or performers
- **Accessories holder:** double runners to hold accessories and colour filters
- **Barn door:** unique rotating barn door with 4 individually rotating blades – makes even the most difficult angle possible
- **Adjustable response time:** choice of fast or slow dimming for tungsten-like simulation - adjustment by DMX protocol
- **Ethernet-DMX node:** data IN through RJ45 connector; data OUT through DMX for daisy chaining
- **Universal data control:** compatible with DMX, RDM, Art-Net, sACN protocols
- **Remote setup:** all parameters can be adjusted by RDM protocol or by web interface
- **PWM adjustment:** choice of different PWM dimming frequencies - continuous mode available
- **Advanced Ethernet node functionalities:** compatible with RDM, LLRP, Zeroconf protocols
- **Local setup:** DMX address and mode, dimming curve and response time through 4-button display with automatic light switch-off
- **Dimming parameters:** choice of square or linear dimming curves
- **DMX:** 8 or 16 bit dimming, CCT, focus, response time and strobe function
- **1 DMX parameter mode:** cCT and focus adjustment through local display and dimming control by DMX
- **Tilt reference on hanging yoke:** index for rapid re-positioning

Optical

- **Calibrated tunable white source:** to ensure consistency between fixtures
- **Optical adjustment:** extended aperture range possible to obtain a tighter beam and a more powerful very wide angle
- **Long life:** outstanding operational lifetime expectation, no need to replace lamps, low maintenance
- **Powerful tunable white:** maximum LED power guaranteed whatever the colour temperature is
- **Beam shaping :** efficient barndoors in any focus position
- **Electronic dimmer:** dimming without clipping or cut-out at low intensity levels; high quality smoothing
- **No colour shift:** colour temperature remains the same when dimming

Construction

- **Made in France :** fully manufactured in Robert Juliat premises retaining complete control over all aspects of quality
- **PSU:** built-in electronic flicker-free power supply for easy, plug-and-play installation
- **Power connectors:** compatible powerCON® TRUE1 IN and OUT connectors for daisy chaining
- **Silent-running cooling fans:** ideal for TV studios and opera houses
- **Electronic thermal management system:** ensures maximum performance of the system without any risk of overheating
- **3 cooling modes available:** includes a silent mode for perfect integration in concert halls
- **Bodywork:** strong sheet metal construction for durability
- **Captive knobs and handles:** additional security when working at height or in transit
- **Easy access to all parts:** easy cleaning and maintenance
- **Safety first:** front accessories safety cable attachment point

Picture:370L

DSEN448_370MF_VW - 08/04/2026

Robert Juliat reserves the right to change or alter any of the items detailed on this page, to increase or improve manufacturing techniques without prior notice.

Robert Juliat S.A.S., 32 rue de Beaumont, 60530 Fresnoy-en-Thelle - France
Telephone : +33 (0)3 44 26 51 89 - info@robertjuliat.fr - www.robertjuliat.com



ROBERT JULIAT

Source (Light quality report(s) available at the end of the document)

- **Lamp type:** LED
- **Power:** 500 W

LED specifications	Power *	Lumen output*	Colour temperature*	Life*	CRI* (min)
TVW01	500 W	31 000 lm	3000K --> 6300K	30 000 h	95

(*) manufacturer's data

Optics

Characteristics

- **Type:** Single lens
- **Range:** 12° to 40° (Beam angle)
7,5° to 60° configuration possible
- **Lens:** 200 mm Fresnel lens

Gel filter

- **Shape:** Square
- **Standard size:** 215x215 mm (8.5x8.5 in)

Photometrics (Photometrics report(s) available at the end of the document)

optics: 12°-40° / Standard / 6000 K

• Optics @ 12°

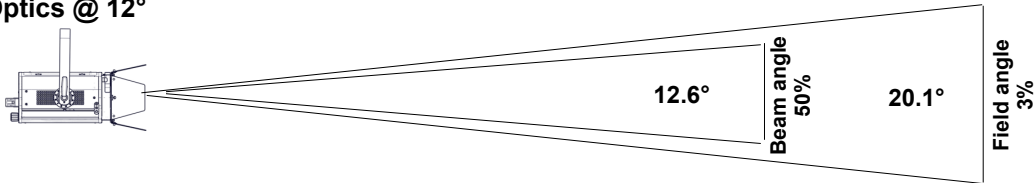

Beam intensity
409 200 cd

Field lumens
17 540 lm

Distance	3 m	5 m	7 m	10 m	12 m	15 m
Diameter	1.1 m	1.8 m	2.5 m	3.5 m	4.3 m	5.3 m
Illumination	45 500 lux	16 500 lux	8 400 lux	4 100 lux	2 850 lux	1 850 lux
Distance	10 ft	15 ft	25 ft	35 ft	40 ft	50 ft
Diameter	3.5 ft	5.3 ft	8.9 ft	12.4 ft	14.2 ft	17.7 ft
Illumination	4 100 fc	1 850 fc	660 fc	340 fc	260 fc	170 fc

• Optics @ 40°

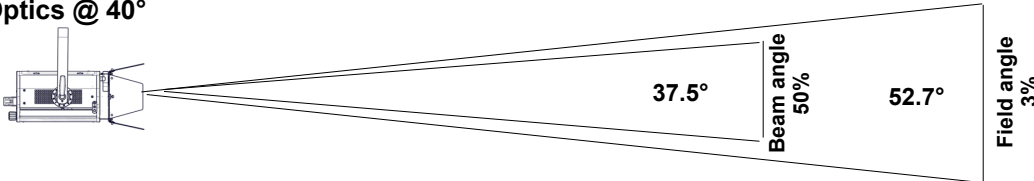

Beam intensity
60 000 cd

Field lumens
23 640 lm

Distance	3 m	5 m	7 m	10 m	12 m	15 m
Diameter	3 m	5 m	6.9 m	9.9 m	11.9 m	14.9 m
Illumination	6 700 lux	2 450 lux	1 250 lux	610 lux	420 lux	270 lux
Distance	10 ft	15 ft	25 ft	35 ft	40 ft	50 ft
Diameter	9.9 ft	14.9 ft	24.8 ft	34.7 ft	39.6 ft	49.5 ft
Illumination	610 fc	270 fc	100 fc	49 fc	38 fc	25 fc

Remote control

- **Data protocol:** USITT DMX512-A
RDM / Art-Net / sACN

- **Data IN connector:** 5 pins XLR male + etherCON RJ45
- **Data OUT connector** 5 pins XLR female



• DMX chart:

Mode 1 (1 channels)

Dimmer

Mode 2 (3 channels)

Dimmer
CCT
Focus

Mode 3 (9 channels)

Dimmer @16
Strobe duration
Strobe speed
Response time
Control mode
CCT @16
Focus

Dimensions and weight

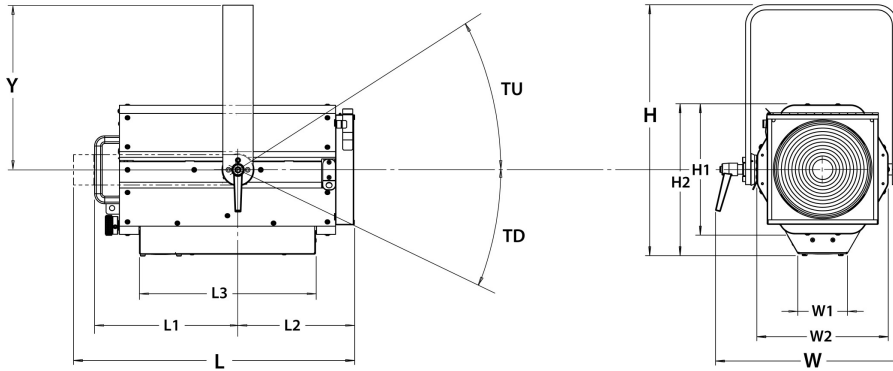

Weight: 16 kg (35.2 lbs)

Height	Length	Width	Yoke	Tilt
H= 459 mm (18.1 in)	L= 514 mm (20.2 in)	W= 370 mm (14.6 in)	Y= 325 mm (12.8 in)	TU= 56°
H1= 259 mm (10.2 in)	L1= 283 mm (11.1 in)	W1= 260 mm (10.2 in)		TD= 90°
H2= 300 mm (11.8 in)	L2= 231 mm (9.1 in)	W2= 98 mm (3.9 in)		
	L3= 350 mm (13.8 in)			

Shipping

- **Weight :** kg (0 lbs)
- **Volume :** m³ (0 ft³)

Installation

- **Minimum distance to illuminated surface:** 1.2 m (3.9 ft)
- **Operating position:**

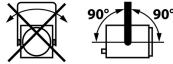

Warranty

- **Fixture: 3 years**
See General Sales Condition on website

Approvals



Construction

- **Housing:** Steel sheet - Aluminium
- **Colour:** Black
- **Cooling:** Low noise variable fan
- **Maximum ambient temperature (Ta):** 40°C (104°F)
- **Maximum case temperature (Tc):** °C (°F)
- **Total heat dissipation:** 2 058 BTU/h
- **Ingress Protection (IP) rating:** IP20

Electrical compatibility

- 220/230 V - 50 Hz
- 220/230 V - 60 Hz
- 245 V - 50 Hz
- 100 V - 50 Hz
- 110/120 V - 60 Hz
- 100 V - 60 Hz
- 208 V - 60 Hz
- Selector: automatic detection

Power input



- **Type:** removable power cord with compatible powerCON® TRUE1 connector (included)
- **Cable:** H07RNF 3G1.5
- **Length:** 3 m (9.8 ft)
- **Power connector:** CEE 7/7 (2P+E NF/Schuko)

Power consumption

Voltage	Frequency	Current	Power	Power factor
230 V	50 Hz	2.78 A	603 W	0.95
110 V	60 Hz	5.91 A	630 W	0.99
100 V	60 Hz	6.59 A	638 W	0.99

Power Supply Unit

- **PSU:** Internal - Electronic PSU - Flicker free with PFC
- **Control:** Local / DMX
- **Protection:** Mains: 2x 10A 1P1D breaker - UL /
- **Power thru:** compatible powerCON® TRUE1 - Maximum of 5 units (230 V) / 2 units (120 V)









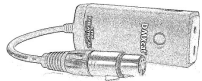

Model

370MF VW	LED 500 W - Variable White Single lens luminaire - 200mm Fresnel - 370MF VW Bizet - DMX focus
-----------------	-----------------------------------------------------------------------------------------------

Options

PCP1716A	16A blue 2P+E 6h IEC60309 power connector	
-----------------	-------------------------------------------	-------------------------------------------------------------------------------------

Accessories

PF1000M2	215x215mm metal filter holder 1 included	
Fusion/RJ	Madrix Radar (RDM monitoring): Fusion RJ licence - access to all RDM parameters of RJ fixtures 1 included	
CF1000	4 rotating leaves on a rotating barndoor - 215x215mm (without safety cable) - Weight: 1.03 Kg	
DMXcat	Bluetooth DMX/RDM Multifunction test tool - City Theatrical DMXcat®	
Fusion/L	Madrix Radar (RDM monitoring): Fusion Large licence - up to 4096 non-RJ RDM fixtures - USB dongle included	
Fusion/M	Madrix Radar (RDM monitoring): Fusion Medium licence - up to 512 non-RJ RDM fixtures - USB dongle included	
Fusion/S	Madrix Radar (RDM monitoring): Fusion Small licence - up to 64 non-RJ RDM fixtures - USB dongle included	
876	Hook clamp 40x10mm with 28mm M10 screw for Ø35 to 50mm pipes - SWL: 50Kg - Weight: 1.25 Kg	
880	Hook clamp 40x10mm with 28mm M10 screw for Ø50 to 63mm pipes - SWL: 50Kg - Weight: 1.36 Kg	
CS2	Safety cable Ø3 mm L= 600mm - SWL: 75 Kg	
CS5	Safety cable Ø1,5 mm L=300mm for front accessory with karabiner and quick link - SWL: 25 Kg	

• Optics @ 12°

Field lumens	Beam lumens	Efficacy	Beam intensity	CCT	Delta uv
17 540 Lm	11 140 Lm		409 200 Cd	6 390 K	-0.0005

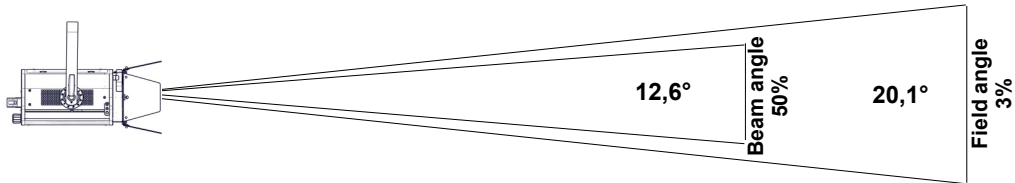

Distance	3 m	5 m	7 m	10 m	12 m	15 m
Field diameter	1,1 m	1,8 m	2,5 m	3,5 m	4,3 m	5,3 m
Illumination	45 500 lux	16 500 lux	8 400 lux	4 100 lux	2 850 lux	1 850 lux
Distance	10 ft	15 ft	25 ft	35 ft	40 ft	50 ft
Field diameter	3,5 ft	5,3 ft	8,9 ft	12,4 ft	14,2 ft	17,7 ft
Illumination	4 100 fc	1 850 fc	660 fc	340 fc	260 fc	170 fc

• Optics @ 25°

Field lumens	Beam lumens	Efficacy	Beam intensity	CCT	Delta uv
21 510 Lm	16 650 Lm		128 900 Cd	6 220 K	0.0006

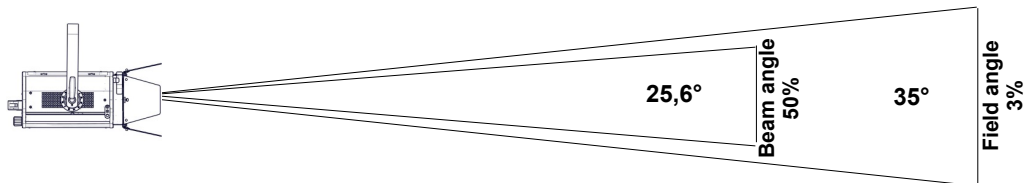

Distance	3 m	5 m	7 m	10 m	12 m	15 m
Field diameter	1,9 m	3,2 m	4,4 m	6,3 m	7,6 m	9,5 m
Illumination	14 500 lux	5 200 lux	2 650 lux	1 300 lux	900 lux	580 lux
Distance	10 ft	15 ft	25 ft	35 ft	40 ft	50 ft
Field diameter	6,3 ft	9,5 ft	15,8 ft	22,1 ft	25,2 ft	31,5 ft
Illumination	1 300 fc	580 fc	210 fc	110 fc	85 fc	55 fc

• Optics @ 40°

Field lumens	Beam lumens	Efficacy	Beam intensity	CCT	Delta uv
23 640 Lm	17 100 Lm		60 000 Cd	6 000 K	0.0006

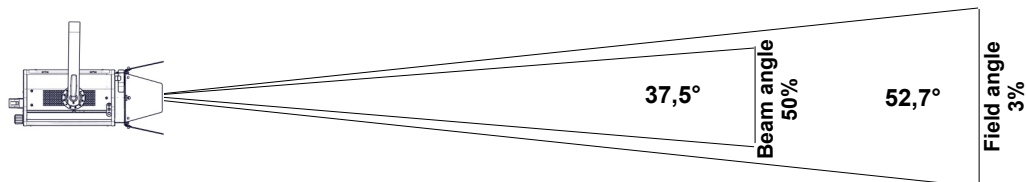

Distance	3 m	5 m	7 m	10 m	12 m	15 m
Field diameter	3 m	5 m	6,9 m	9,9 m	11,9 m	14,9 m
Illumination	6 700 lux	2 450 lux	1 250 lux	610 lux	420 lux	270 lux
Distance	10 ft	15 ft	25 ft	35 ft	40 ft	50 ft
Field diameter	9,9 ft	14,9 ft	24,8 ft	34,7 ft	39,6 ft	49,5 ft
Illumination	610 fc	270 fc	100 fc	49 fc	38 fc	25 fc

• Optics @ 12°

Field lumens	Beam lumens	Efficacy	Beam intensity	CCT	Delta uv
12 630 Lm	7 990 Lm		299 500 Cd	3 200 K	-0.001

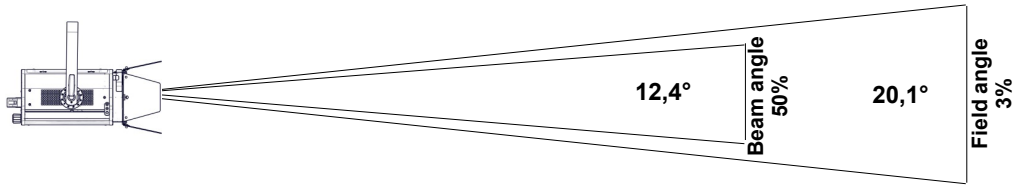

Distance	3 m	5 m	7 m	10 m	12 m	15 m
Field diameter	1,1 m	1,8 m	2,5 m	3,5 m	4,3 m	5,3 m
Illumination	33 500 lux	12 000 lux	6 200 lux	3 000 lux	2 100 lux	1 350 lux
Distance	10 ft	15 ft	25 ft	35 ft	40 ft	50 ft
Field diameter	3,5 ft	5,3 ft	8,9 ft	12,4 ft	14,2 ft	17,7 ft
Illumination	3 000 fc	1 350 fc	480 fc	250 fc	190 fc	120 fc

• Optics @ 25°

Field lumens	Beam lumens	Efficacy	Beam intensity	CCT	Delta uv
15 760 Lm	12 230 Lm		94 900 Cd	3 190 K	-0.0009

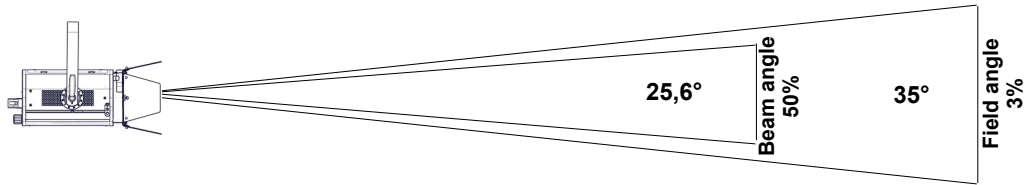

Distance	3 m	5 m	7 m	10 m	12 m	15 m
Field diameter	1,9 m	3,2 m	4,4 m	6,3 m	7,6 m	9,5 m
Illumination	11 000 lux	3 800 lux	1 950 lux	950 lux	660 lux	430 lux
Distance	10 ft	15 ft	25 ft	35 ft	40 ft	50 ft
Field diameter	6,3 ft	9,5 ft	15,8 ft	22,1 ft	25,2 ft	31,5 ft
Illumination	950 fc	430 fc	160 fc	80 fc	60 fc	38 fc

• Optics @ 40°

Field lumens	Beam lumens	Efficacy	Beam intensity	CCT	Delta uv
16 860 Lm	12 150 Lm		43 300 Cd	3 130 K	-0.0007

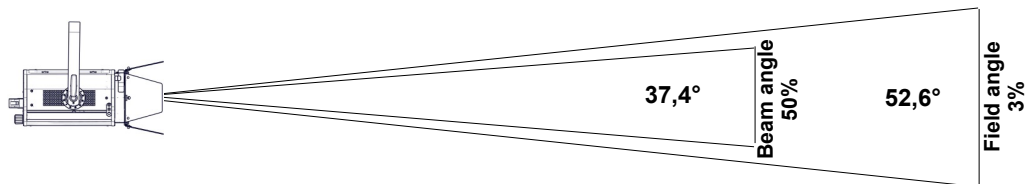

Distance	3 m	5 m	7 m	10 m	12 m	15 m
Field diameter	3 m	4,9 m	6,9 m	9,9 m	11,9 m	14,8 m
Illumination	4 850 lux	1 750 lux	890 lux	440 lux	310 lux	200 lux
Distance	10 ft	15 ft	25 ft	35 ft	40 ft	50 ft
Field diameter	9,9 ft	14,8 ft	24,7 ft	34,6 ft	39,5 ft	49,4 ft
Illumination	440 fc	200 fc	70 fc	36 fc	28 fc	18 fc

• Optics @ 7,5°

Field lumens	Beam lumens	Efficacy	Beam intensity	CCT	Delta uv
6 550 Lm	3 790 Lm		373 300 Cd	6 530 K	-0.0014

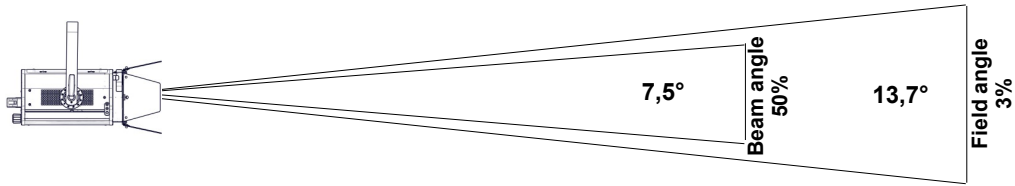

Distance	3 m	5 m	7 m	10 m	12 m	15 m
Field diameter	0,7 m	1,2 m	1,7 m	2,4 m	2,9 m	3,6 m
Illumination	41 500 lux	15 000 lux	7 700 lux	3 750 lux	2 600 lux	1 700 lux
Distance	10 ft	15 ft	25 ft	35 ft	40 ft	50 ft
Field diameter	2,4 ft	3,6 ft	6 ft	8,4 ft	9,6 ft	12 ft
Illumination	3 750 fc	1 700 fc	600 fc	310 fc	240 fc	150 fc

• Optics @ 30°

Field lumens	Beam lumens	Efficacy	Beam intensity	CCT	Delta uv
14 710 Lm	9 980 Lm		58 500 Cd	6 720 K	-0.002

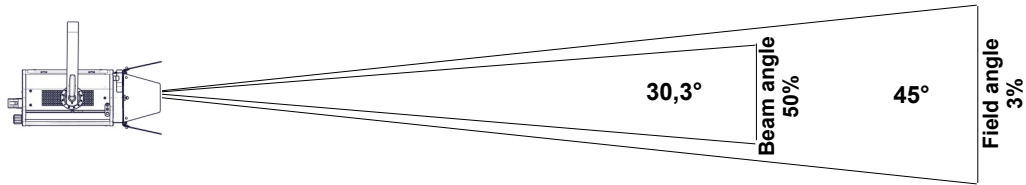

Distance	3 m	5 m	7 m	10 m	12 m	15 m
Field diameter	2,5 m	4,1 m	5,8 m	8,3 m	9,9 m	12,4 m
Illumination	6 600 lux	2 350 lux	1 200 lux	590 lux	410 lux	270 lux
Distance	10 ft	15 ft	25 ft	35 ft	40 ft	50 ft
Field diameter	8,3 ft	12,4 ft	20,7 ft	29 ft	33,1 ft	41,4 ft
Illumination	590 fc	270 fc	95 fc	48 fc	37 fc	24 fc

• Optics @ 60°

Field lumens	Beam lumens	Efficacy	Beam intensity	CCT	Delta uv
30 410 Lm	16 990 Lm		23 500 Cd	5 980 K	0.0008

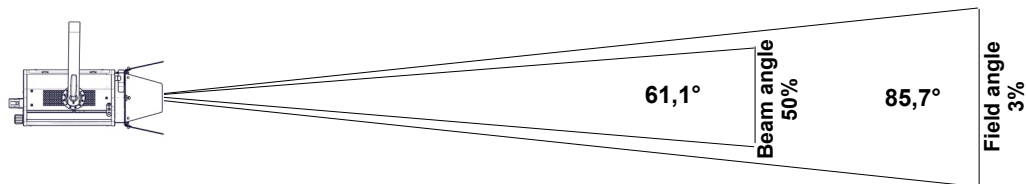

Distance	3 m	5 m	7 m	10 m	12 m	15 m
Field diameter	5,6 m	9,3 m	13 m	18,6 m	22,3 m	27,8 m
Illumination	2 650 lux	950 lux	480 lux	240 lux	170 lux	110 lux
Distance	10 ft	15 ft	25 ft	35 ft	40 ft	50 ft
Field diameter	18,6 ft	27,8 ft	46,4 ft	64,9 ft	74,2 ft	92,8 ft
Illumination	240 fc	110 fc	38 fc	20 fc	15 fc	10 fc

• Optics @ 7,5°

Field lumens	Beam lumens	Efficacy	Beam intensity	CCT	Delta uv
4 760 Lm	2 760 Lm		274 800 Cd	3 210 K	-0.0017

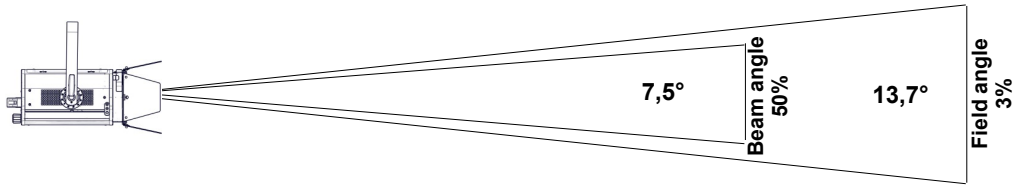

Distance	3 m	5 m	7 m	10 m	12 m	15 m
Field diameter	0,7 m	1,2 m	1,7 m	2,4 m	2,9 m	3,6 m
Illumination	31 000 lux	11 000 lux	5 700 lux	2 750 lux	1 950 lux	1 250 lux
Distance	10 ft	15 ft	25 ft	35 ft	40 ft	50 ft
Field diameter	2,4 ft	3,6 ft	6 ft	8,4 ft	9,6 ft	12 ft
Illumination	2 750 fc	1 250 fc	440 fc	230 fc	180 fc	110 fc

• Optics @ 30°

Field lumens	Beam lumens	Efficacy	Beam intensity	CCT	Delta uv
10 740 Lm	7 220 Lm		43 200 Cd	3 230 K	-0.002

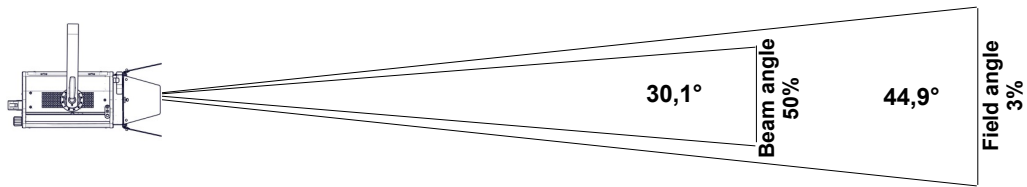

Distance	3 m	5 m	7 m	10 m	12 m	15 m
Field diameter	2,5 m	4,1 m	5,8 m	8,3 m	9,9 m	12,4 m
Illumination	4 850 lux	1 750 lux	890 lux	440 lux	310 lux	200 lux
Distance	10 ft	15 ft	25 ft	35 ft	40 ft	50 ft
Field diameter	8,3 ft	12,4 ft	20,7 ft	28,9 ft	33,1 ft	41,3 ft
Illumination	440 fc	200 fc	70 fc	36 fc	28 fc	18 fc

• Optics @ 60°

Field lumens	Beam lumens	Efficacy	Beam intensity	CCT	Delta uv
22 240 Lm	13 030 Lm		17 600 Cd	3 130 K	-0.0002

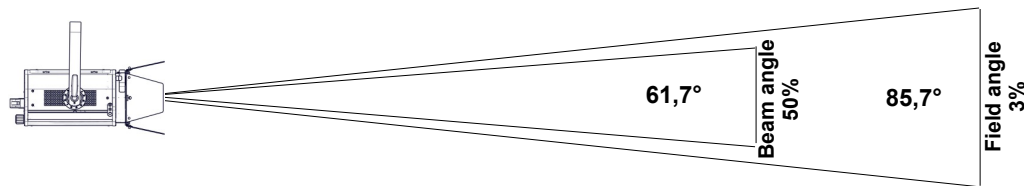

Distance	3 m	5 m	7 m	10 m	12 m	15 m
Field diameter	5,6 m	9,3 m	13 m	18,6 m	22,3 m	27,8 m
Illumination	2 000 lux	710 lux	360 lux	180 lux	130 lux	80 lux
Distance	10 ft	15 ft	25 ft	35 ft	40 ft	50 ft
Field diameter	18,6 ft	27,8 ft	46,4 ft	64,9 ft	74,2 ft	92,8 ft
Illumination	180 fc	80 fc	29 fc	15 fc	12 fc	8 fc

CCT	DeltaUV	CRI Ra	CRI R9	CQS Qa	TM30-18 Rf	TM30-18 Rg	TLCI	SSI [3187]
3 190K	-0.0009	98	98	98	96	102	99	86

CRI - CIE Colour Rendering Index

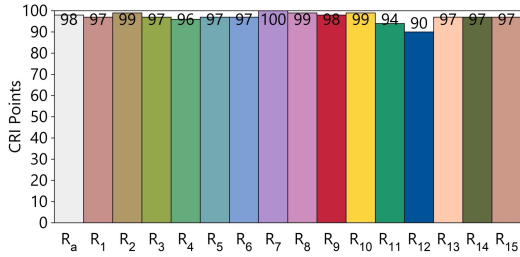

TLCI - Television Lighting Consistency Index

Test : CCT = P3187 (-0.2)
 TLCI-2012 : 99 (P3187)

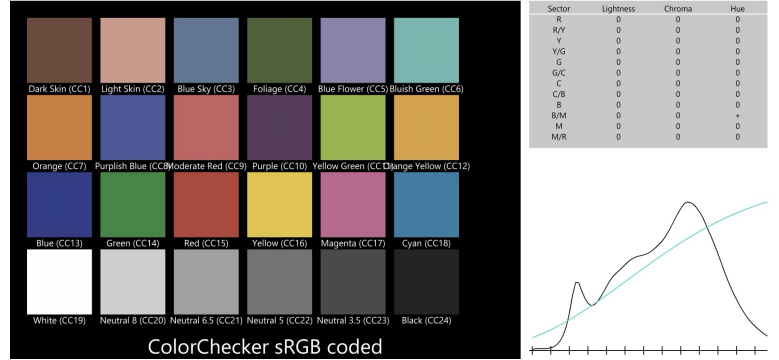

CQS - NIST Colour Quality Scale

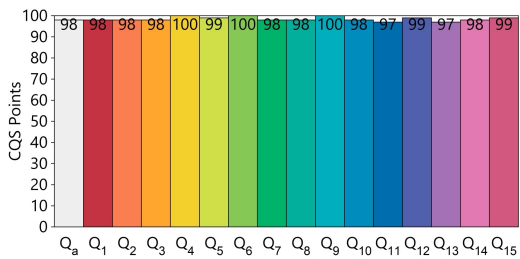

ANSI/IES TM-30-18 Colour Rendition Report

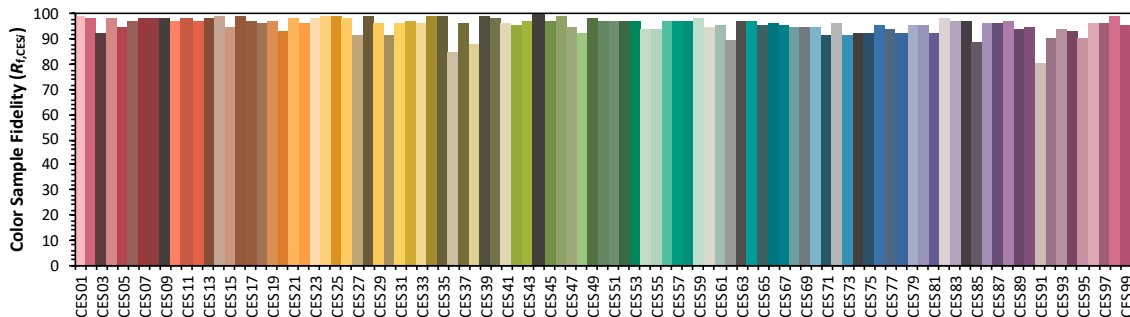
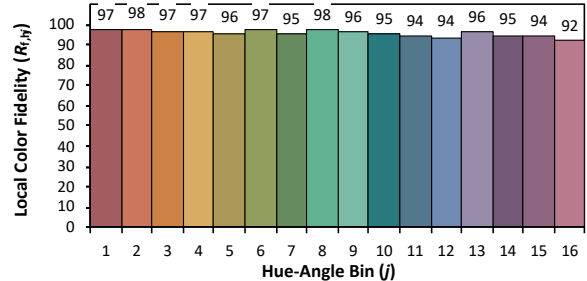
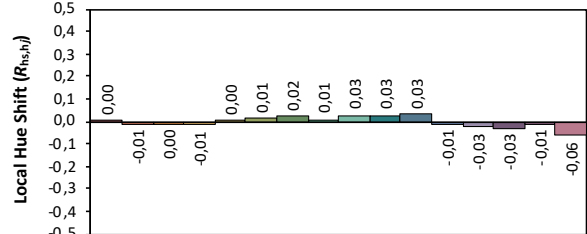
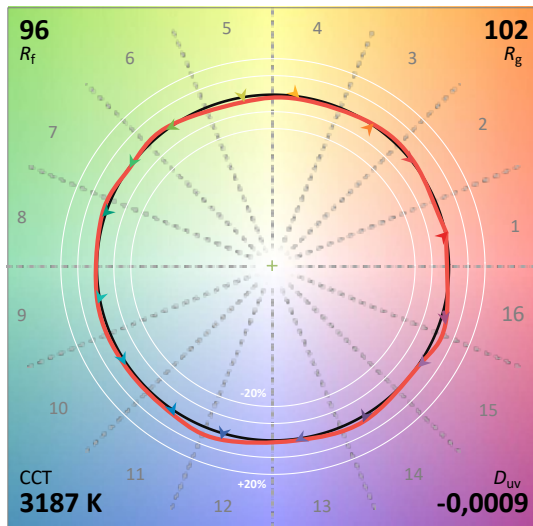
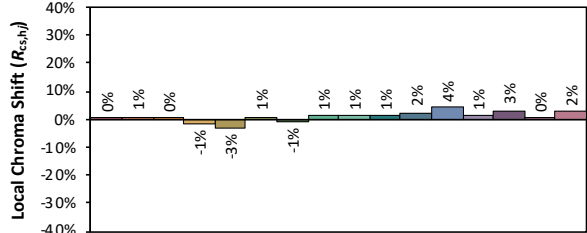
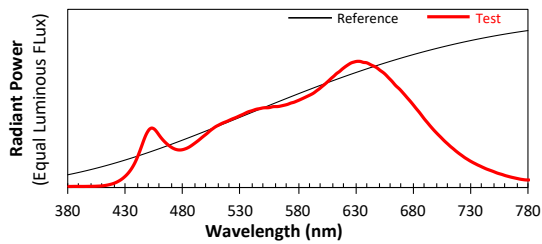

Colours are for visual orientation purposes only. Created with the IES TM-30-18 Calculator Version 2.00

CCT	DeltaUV	CRI Ra	CRI R9	CQS Qa	TM30-18 Rf	TM30-18 Rg	TLCI	SSI [6220]
6 220K	0.0006	97	96	95	94	102	99	74

CRI - CIE Colour Rendering Index

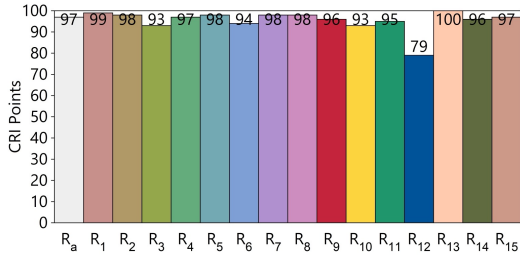

TLCI - Television Lighting Consistency Index

Test : CCT = D6222 (-0.5)
 TLCI-2012 : 99 (D6222)



CQS - NIST Colour Quality Scale

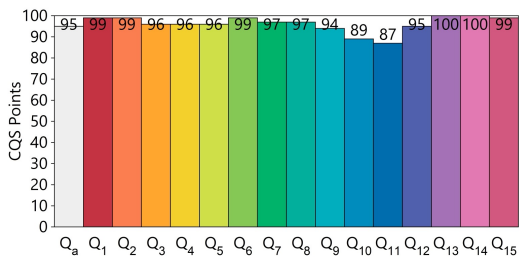

ANSI/IES TM-30-18 Colour Rendition Report

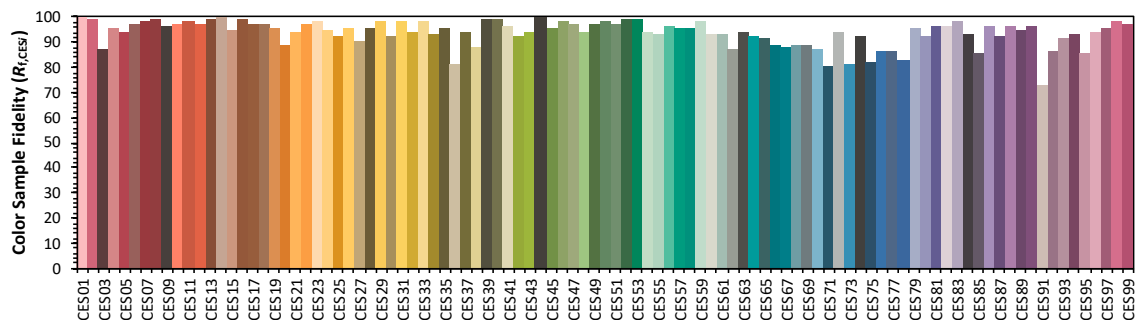
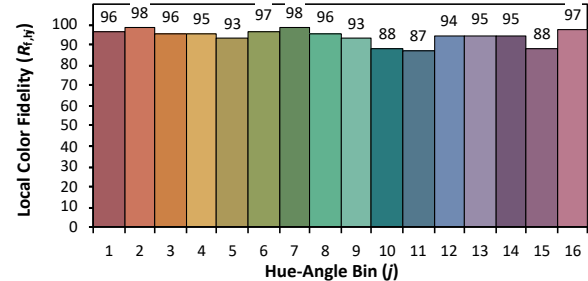
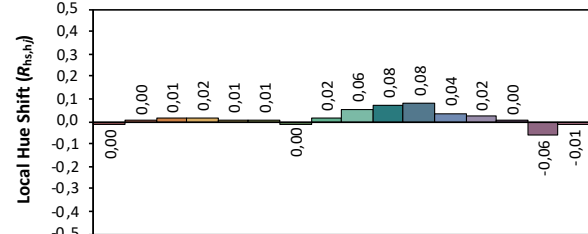
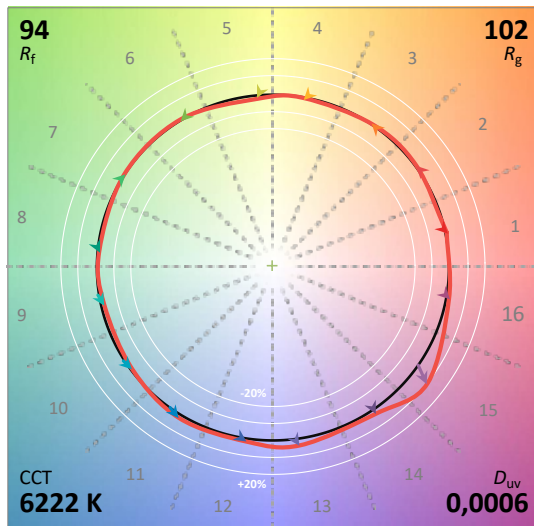
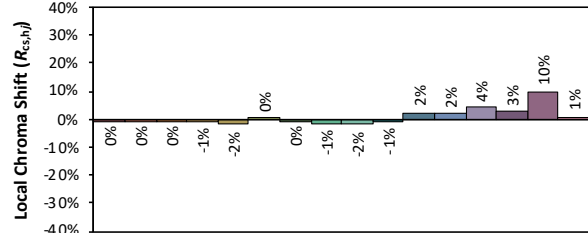
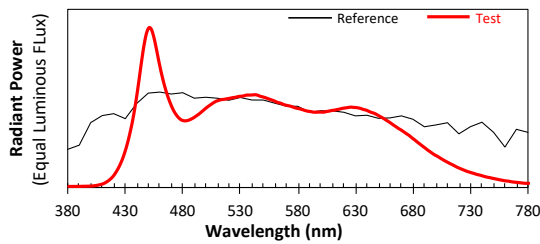

Colours are for visual orientation purposes only. Created with the IES TM-30-18 Calculator Version 2.00