

BIZET - 674SX CW

670SX - LED 600 W



- **Type:** Profile spot
- **Source:** LED 600 W
- **Optics:** 16° to 35° zoom
- **Colour temperature:** Cool White

Profile spot

The most powerful daylight profile spot

The Bizet 670SX profile spot is a mighty profile series, delivering superior performance with a 600W cool white LED source. It surpasses the Charles model in every aspect—being more compact, lighter, more powerful, quieter, and more affordable. Additionally, it matches the output and CRI of the 2500W HID D'Artagnan, while offering electronic dimming and zero standby power consumption. Its innovative design ensures full compatibility with Robert Juliat's 600SX, 713SX, and 714SX profile lens tubes, making it an ideal solution for long-throw front-of-house applications in medium to large venues.

Features

- **Multi-function double gate:** simultaneous use of gobos and iris. Sharp focus of both gobo and shutter
- **Shutter gate:** up to 8 shutters. Remove shutters for easy maintenance or tuck fully inside gate for secure transport
- **User-friendly shutter-lock system:** secures shutters' setting in any circumstances (locking efficient up to 4 shutters)
- **Universal gobo holder:** "A" size glass and metal gobo
- **Lens tube lock feature:** secures rotating lens tube against unwanted movement
- **90° rotating lens tube / gate / front accessories holder:** rotation of the projected image is always possible – no need to move the yoke
- **Internal glass filter holder:** long term use of durable coloured, dichroic or textured glass
- **Adjustable response time:** choice of fast or slow dimming for tungsten-like simulation - adjustment by DMX protocol
- **Ethernet-DMX node:** data IN through RJ45 connector; data OUT through DMX for daisy chaining
- **Universal data control:** compatible with DMX, RDM, Art-Net, sACN protocols
- **Remote setup:** all parameters can be adjusted by RDM protocol or by web interface
- **PWM adjustment:** choice of different PWM dimming frequencies - continuous mode available
- **Advanced Ethernet node functionalities:** compatible with RDM, LLRP, Zeroconf protocols
- **Local setup:** DMX address and mode, dimming curve and response time through 4-button display with automatic light switch-off
- **Dimming parameters:** choice of square or linear dimming curves
- **DMX:** 8 or 16 bit dimming, response time and strobe function
- **Easy focus reference:** graduated scale on side of the unit; fast and easy refocusing
- **Tilt reference on hanging yoke:** index for rapid re-positioning

Optical

- **Long life:** outstanding operational lifetime expectation, no need to replace lamps, low maintenance
- **Coated SX optical system:** double condenser optics for exceptional optical quality - Anti-Reflective coating to ensure optimal light transmission
- **Variable zoom optics:** sharp focus at every beam angle. Independent control of image size and focus. Focus handles on both sides
- **Coated zoom lenses:** all zoom lenses are anti-reflection coated (AR) to ensure a maximum transmission of light.
- **Electronic dimmer:** dimming without clipping or cut-out at low intensity levels; high quality smoothing
- **No colour shift:** colour temperature remains the same when dimming

Construction

- **Made in France :** fully manufactured in Robert Juliat premises retaining complete control over all aspects of quality
- **Lamp house compatible with 611SX, 613SX, 614SX, 713SX and 714SX lens tubes:** lamp house only available for upgrade of existing tungsten fixtures
- **PSU:** built-in electronic flicker-free power supply for easy, plug-and-play installation
- **Power connectors:** compatible powerCON® TRUE1 IN and OUT connectors for daisy chaining
- **Silent-running cooling fans:** ideal for TV studios and opera houses
- **Electronic thermal management system:** ensures maximum performance of the system without any risk of overheating
- **3 cooling modes available:** includes a silent mode for perfect integration in concert halls
- **Bodywork:** strong sheet metal construction for durability
- **Captive knobs and handles:** additional security when working at height or in transit
- **Spare parts and accessories:** interchangeable across the tungsten, discharge or LED ranges, reducing running costs
- **Easy access to all parts:** easy cleaning and maintenance

Picture:674SX

DSEN425_674SX_CW_Preliminary - 03/04/2025 - Preliminary data
Robert Juliat reserves the right to change or alter any of the items detailed on this page, to increase or improve manufacturing techniques without prior notice.
Robert Juliat S.A.S., 32 rue de Beaumont, 60530 Fresnoy-en-Thelle - France
Telephone : +33 (0)3 44 26 51 89 - info@robertjuliat.fr - www.robertjuliat.com



ROBERT JULIAT

Source (Light quality report(s) available at the end of the document)

- **Lamp type:** LED
- **Power:** 600 W

LED specifications	Power *	Lumen output*	Colour temperature*	Life*
TCW02	600 W	38 000 lm	6500K	30 000 h

(*) manufacturer's data

Optics

Characteristics

- **Type:** Zoom
- **Range:** 16° to 35° (Field angle)
- **Focal length:** 131 - 268 mm

Gel filter

- **Shape:** Square
- **Standard size:** 180x180 mm (7.1x7.1 in)
- **Optional size:** 185x185 mm (7.3x7.3 in)

Gobo

- **Size:** A
- **Material:** Metal
Glass

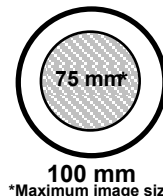

Photometrics (Photometrics report(s) available at the end of the document)

optics: 16°-35° / Standard

• Optics @ 16°

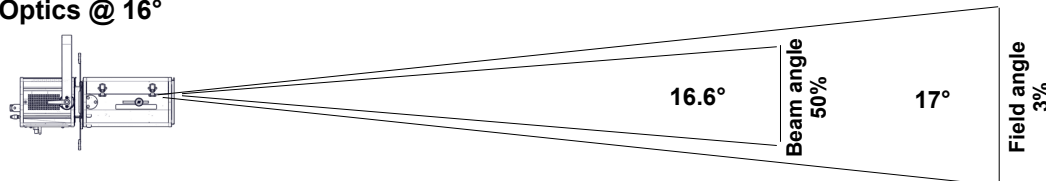

Beam intensity
495 300 cd

Field lumens
25 450 lm

Efficacy
36 lm/W

Distance	5 m	10 m	15 m	20 m	25 m	30 m
Diameter	1.5 m	3 m	4.5 m	6 m	7.5 m	9 m
Illumination	20 000 lux	5 000 lux	2 250 lux	1 250 lux	800 lux	560 lux
Distance	15 ft	35 ft	50 ft	65 ft	80 ft	100 ft
Diameter	4.5 ft	10.5 ft	14.9 ft	19.4 ft	23.9 ft	29.9 ft
Illumination	2 250 fc	410 fc	200 fc	120 fc	80 fc	50 fc

• Optics @ 35°

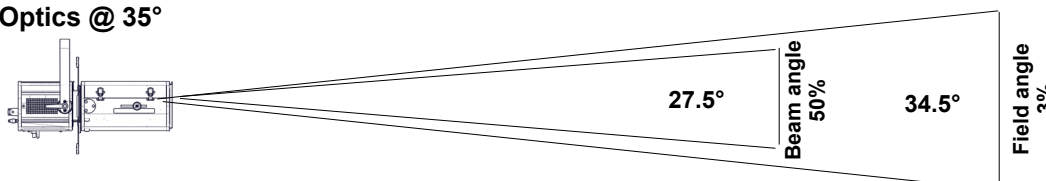

Beam intensity
140 100 cd

Field lumens
24 760 lm

Efficacy
35 lm/W

Distance	5 m	10 m	15 m	20 m	25 m	30 m
Diameter	3.1 m	6.2 m	9.3 m	12.4 m	15.5 m	18.6 m
Illumination	5 700 lux	1 450 lux	630 lux	360 lux	230 lux	160 lux
Distance	15 ft	35 ft	50 ft	65 ft	80 ft	100 ft
Diameter	9.3 ft	21.7 ft	31.1 ft	40.4 ft	49.7 ft	62.1 ft
Illumination	630 fc	120 fc	60 fc	34 fc	22 fc	15 fc

Remote control

- **Data protocol:** USITT DMX512-A
RDM / Art-Net / sACN

- **Data IN connector:** 5 pins XLR male + etherCON RJ45
- **Data OUT connector:** 5 pins XLR female



• DMX chart:

Mode 1 (1 channels)

Dimmer

Mode 2 (6 channels)

Dimmer
Dimmer fine
Strobe duration
Strobe speed
Response time
Control mode

Dimensions and weight

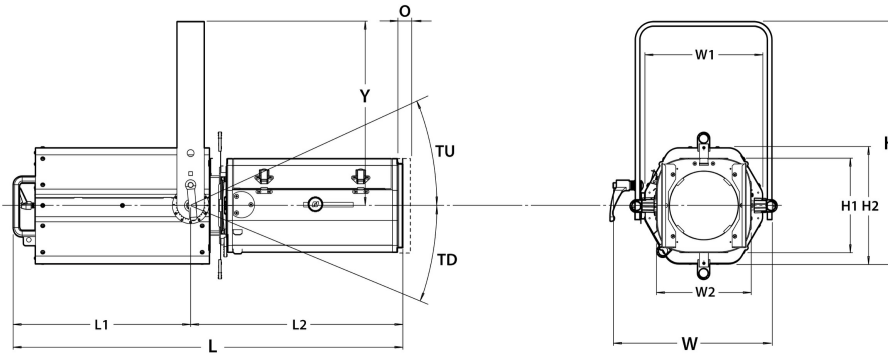

Weight: 20.8 kg (45.8 lbs)

Height	Length	Width	Yoke	Tilt	Option
H= 535 mm (21.1 in)	L= 855 mm (33.7 in)	W= 347 mm (13.7 in)	Y= 405 mm (15.9 in)	TD= 90°	O= 25 mm (1 in)
H'= 445 mm (17.5 in)	L1= 390 mm (15.4 in)	W1= 259 mm (10.2 in)	Y'= 315 mm (12.4 in)		
H1= 208 mm (8.2 in)	L2= 465 mm (18.3 in)	W2= 208 mm (8.2 in)			
H2= 259 mm (10.2 in)					

Shipping

- **Weight :** 24 kg (52.8 lbs)
- **Volume :** .13 m³ (4.73 ft³)

Installation

- **Minimum distance to illuminated surface:** (0.0 ft)
- **Operating position:**

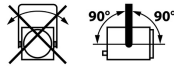

Warranty

- **Fixture: 3 years**
See General Sales Condition on website

Approvals



Construction

- **Housing:** Steel sheet - Aluminium
- **Colour:** Black
- **Cooling:** Low noise variable fan
- **Maximum ambient temperature (Ta):** 40°C (104°F)
- **Maximum case temperature (Tc):** 90°C (194°F)
- **Total heat dissipation:** 2 406 BTU/h
- **Ingress Protection (IP) rating:** IP20

Electrical compatibility

- 220/230 V - 50 Hz
- 220/230 V - 60 Hz
- 245 V - 50 Hz
- 100 V - 50 Hz
- 110/120 V - 60 Hz
- 100 V - 60 Hz
- 208 V - 60 Hz
- Selector: automatic detection

Power input



- **Type:** removable power cord with compatible powerCON® TRUE1 connector (included)
- **Cable:** H07RNF 3G1.5
- **Length:** 3 m (9.8 ft)
- **Power connector:** CEE 7/7 (2P+E NF/Schuko)

Power consumption

Voltage	Frequency	Current	Power	Power factor
230 V	50 Hz	3.22 A	705 W	0.96
245 V	50 Hz	3.04 A	704 W	0.95
208 V	60 Hz	3.53 A	704 W	0.97



Power Supply Unit

- **PSU:** Internal - Electronic PSU - Flicker free with PFC
- **Control:** Local / DMX
- **Protection:** Mains: 2x 10A 1P1D breaker - UL /
- **Power thru:** compatible powerCON® TRUE1 - Maximum of 5 units (230 V) / 2 units (120 V)













Model





674SX CW	LED 600 W Profile spot - 674SX CW Bizet - Cool White - 16/35°
-----------------	---

Options

CAV600E	Double slot front cassette for 185x185mm accessories	
CAV600	Double slot front cassette for 180x180mm accessories	
PCP1716A	16A blue 2P+E 6h IEC60309 power connector	

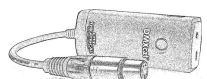
Accessories

D8	Shutter for SX series 4 included	
PF500M2	180x180mm metal filter holder 1 included	
SGUX	Universal "A" size gobo-holder (metal, glass, frosted glass) 1 included	
FO100-10	Ø97mm optical filter for coloured LED source - typ 10 1 included	
IWSX755	Drop-in iris (monoplane) with holder - Weight: 0.26 Kg	
D8	Shutter for SX series	
PF600M2	185x185mm metal filter holder	
G500	180x180mm safety grid	
CAV600A	Double slot front cassette for 180x180mm accessories - Weight: 0.43 Kg	
CAV600AE	Double slot front cassette for 185x185mm accessories - Weight: 0.45 Kg	
RPF613	180x180mm front extension cassette for 215x215mm accessories without fan (recommended for dark colours on 613SX/663SX) - Weight: 1.5 Kg	
RPF613E	180x180mm front extension cassette for 245x245mm accessories without fan (recommended for dark colours on 613SX/663SX)	
VD120	120x120mm frosted glass	

TH600	180x180mm "Top hat" (without safety cable) - ø150mm / 150mm long	
DMXcat	Bluetooth DMX/RDM Multifunction test tool - City Theatrical DMXcat®	
876	Hook clamp 40x10mm with 28mm M10 screw for Ø35 to 50mm pipes - SWL: 50Kg - Weight: 1.25 Kg	
880	Hook clamp 40x10mm with 28mm M10 screw for Ø50 to 63mm pipes - SWL: 50Kg - Weight: 1.36 Kg	
CS2	Safety cable Ø3 mm L= 600mm - SWL: 75 Kg	

• Optics @ 16°

Field lumens	Beam lumens	Efficacy	Beam intensity	CCT	Delta uv
25 450 Lm	25 050 Lm	36 Lm/W	495 300 Cd	6 280 K	-0.0029

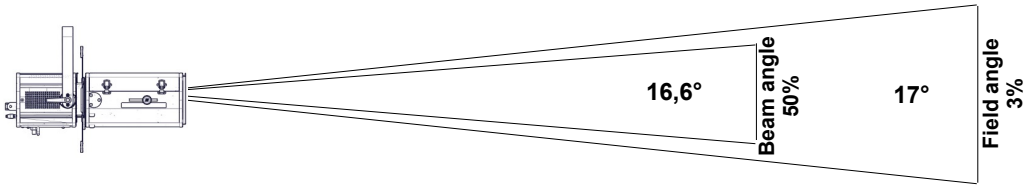

Distance	5 m	10 m	15 m	20 m	25 m	30 m
Field diameter	1,5 m	3 m	4,5 m	6 m	7,5 m	9 m
Illumination	20 000 lux	5 000 lux	2 250 lux	1 250 lux	800 lux	560 lux
Distance	15 ft	35 ft	50 ft	65 ft	80 ft	100 ft
Field diameter	4,5 ft	10,5 ft	14,9 ft	19,4 ft	23,9 ft	29,9 ft
Illumination	2 250 fc	410 fc	200 fc	120 fc	80 fc	50 fc

• Optics @ 35°

Field lumens	Beam lumens	Efficacy	Beam intensity	CCT	Delta uv
24 760 Lm	18 760 Lm	35 Lm/W	140 100 Cd	6 250 K	-0.0035

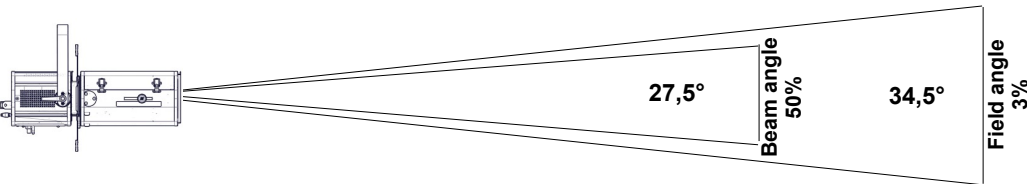

Distance	5 m	10 m	15 m	20 m	25 m	30 m
Field diameter	3,1 m	6,2 m	9,3 m	12,4 m	15,5 m	18,6 m
Illumination	5 700 lux	1 450 lux	630 lux	360 lux	230 lux	160 lux
Distance	15 ft	35 ft	50 ft	65 ft	80 ft	100 ft
Field diameter	9,3 ft	21,7 ft	31,1 ft	40,4 ft	49,7 ft	62,1 ft
Illumination	630 fc	120 fc	60 fc	34 fc	22 fc	15 fc

• Optics @ 15°

Field lumens	Beam lumens	Efficacy	Beam intensity	CCT	Delta uv
23 620 Lm	23 230 Lm	34 Lm/W	605 600 Cd	6 710 K	-0.0037

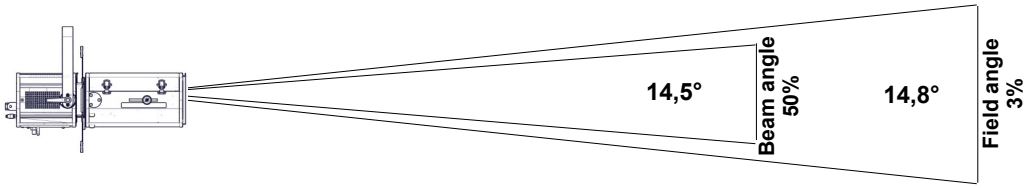

Distance	5 m	10 m	15 m	20 m	25 m	30 m
Field diameter	1,3 m	2,6 m	3,9 m	5,2 m	6,5 m	7,8 m
Illumination	24 500 lux	6 100 lux	2 700 lux	1 550 lux	970 lux	680 lux
Distance	15 ft	35 ft	50 ft	65 ft	80 ft	100 ft
Field diameter	3,9 ft	9,1 ft	13 ft	16,9 ft	20,8 ft	26 ft
Illumination	2 700 fc	500 fc	250 fc	150 fc	95 fc	65 fc

• Optics @ 40°

Field lumens	Beam lumens	Efficacy	Beam intensity	CCT	Delta uv
24 090 Lm	18 630 Lm	34 Lm/W	103 400 Cd	6 410 K	-0.0038

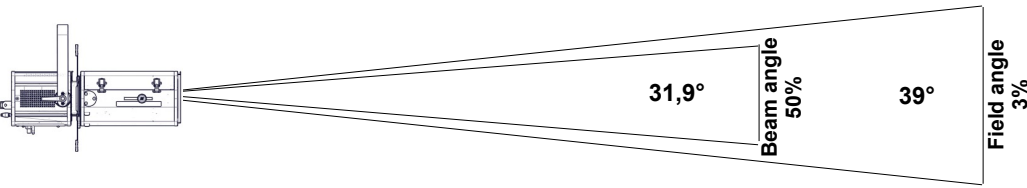

Distance	5 m	10 m	15 m	20 m	25 m	30 m
Field diameter	3,5 m	7,1 m	10,6 m	14,2 m	17,7 m	21,2 m
Illumination	4 150 lux	1 050 lux	460 lux	260 lux	170 lux	120 lux
Distance	15 ft	35 ft	50 ft	65 ft	80 ft	100 ft
Field diameter	10,6 ft	24,8 ft	35,4 ft	46 ft	56,7 ft	70,8 ft
Illumination	460 fc	85 fc	42 fc	25 fc	17 fc	11 fc

Light quality report

CCT	DeltaUV	CRI Ra	CRI R9	CQS Qa	TM30-18 Rf	TM30-18 Rg	TLCI	SSI [6315]
6 320K	-0.0036	94	79	89	90	101	93	71

CRI - CIE Colour Rendering Index

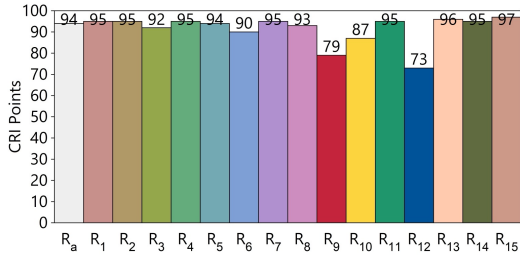

TLCI - Television Lighting Consistency Index

Test : CCT = D6316 (-1.3)
 TLCI-2012 : 93 (D6316)

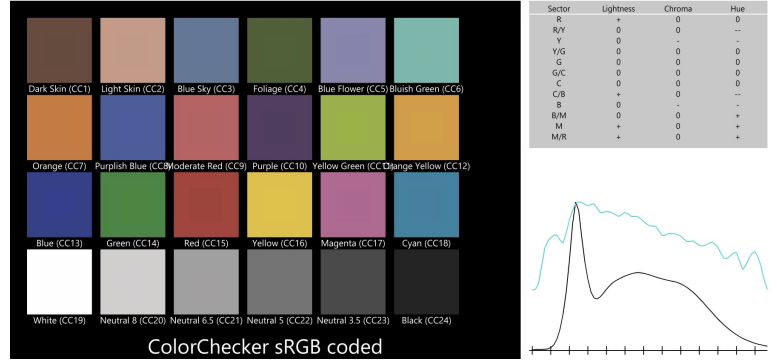

CQS - NIST Colour Quality Scale

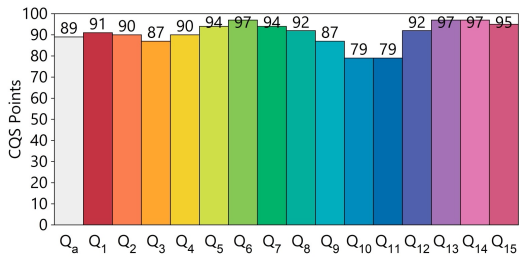

ANSI/IES TM-30-18 Colour Rendition Report

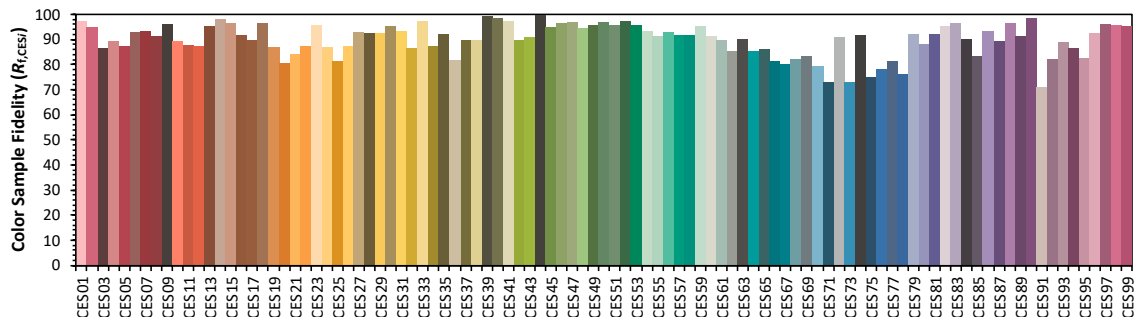
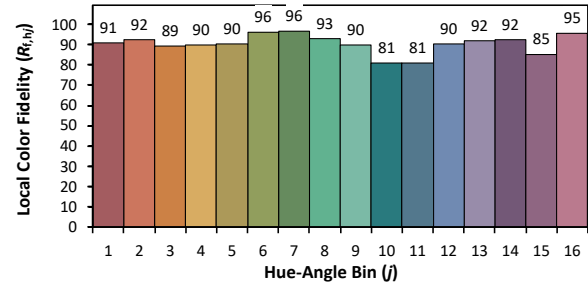
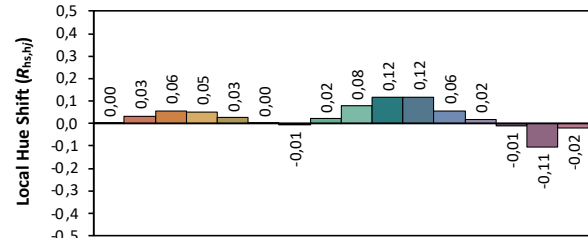
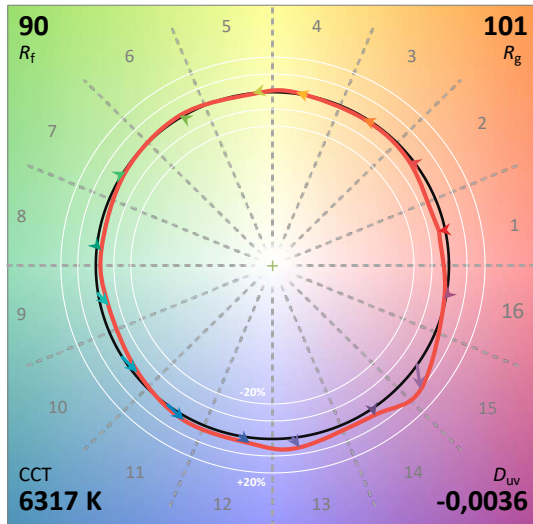
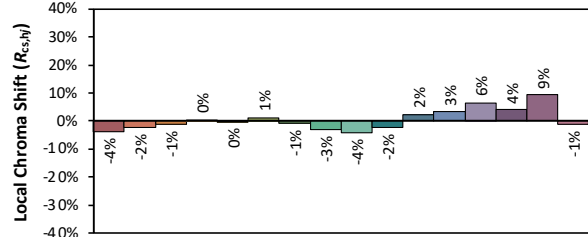
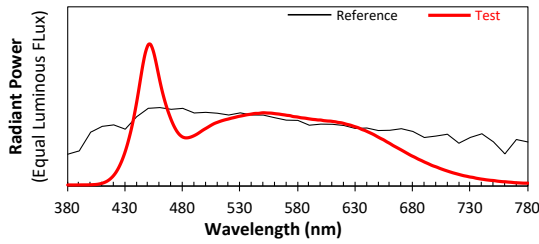

Colours are for visual orientation purposes only. Created with the IES TM-30-18 Calculator Version 2.00