

SULLY - 654SX 4C

650SX - 4 COLOURS LED 200W



- **Type:** Profile spot
- **Source:** 4 colours LED 200W
- **Optics:** 16° to 35° zoom

Profile spot

The new colourful classics

Sully 4C is a series of variable zoom profile featuring a 4-colour LED source and integrating an innovative software platform named RJ Color. With advanced setting and control modes, these profile spots deliver perfect whites and high quality saturated and pastel colours. Sully 4C is fully manufactured in France at Robert Juliat premises. Each LED engine is factory-calibrated to ensure colour consistency from one profile to another. In addition, the Sully 4C LED retrofit compartment is an ideal economic and technological solution to convert 600SX tungsten fixtures.

Features

- **Light intensity:** 8 or 16 bit dimming and strobe function
- **Colour control:** CIE XY, Hue saturation, RGB (with choice of the colour space - Native / sRGB / REC.709 / REC.2020 / ProPhoto) or RAW modes
- **Calibrated white sources:** 3 white presets reproducing tungsten 3000 K or 3200 K lamps, or discharge 6500 K lamps
- **Colour Temperature adjustment (CCT):** white from 1700 to 10000 Kelvin with Delta UV control (+/- Green – Magenta)
- **Colour mixing optimization:** choice of High Quality or High Brightness mode
- **Colour filter simulation:** 300 colour filters included with transmission / saturation adjustment - Fade time and type adjustment between 2 colour filters for adjustable transition
- **DimShift function:** when dimming the light, the colours follow the Planck curve (tungsten redshift emulation) - Available on all sources (white presets, any CCT value) and all colour filters
- **1 parameter DMX mode:** filter or colour selection through local display and dimming control by DMX (8 or 16 bits)
- **Adjustable response time:** choice of fast or slow dimming for tungsten-like simulation - adjustment by DMX - 3 modes available: tungsten, linear and linear with flash detection
- **Multi-function double gate:** simultaneous use of gobos and iris. Sharp focus of both gobo and shutter
- **Shutter gate:** up to 8 shutters. Remove shutters for easy maintenance or tuck fully inside gate for secure transport
- **User-friendly shutter-lock system:** secures shutters' setting in any circumstances (locking efficient up to 4 shutters)
- **Lens tube lock feature:** secures rotating lens tube against unwanted movement
- **90° rotating lens tube / gate / front accessories holder:** rotation of the projected image is always possible while the lamp remains vertical – no need to move the yoke
- **Internal glass filter holder:** long term use of durable coloured, dichroic and textured glass or gels
- **PWM adjustment:** choice of different PWM dimming frequencies
- **Local setup:** dMX address and mode, dimming curve and response time through 4-button display with automatic light switch-off
- **Dimming parameters:** choice of square, linear or tungsten dimming curves

Optical

- **Long life:** outstanding operational lifetime expectation, no need to replace lamps, low maintenance
- **4-colour mixing LED system:** Red, Green, Blue, and Lime
- **Thermal management of each colour:** thanks to the thermal management algorithms, the colours you have set will stay the same during the performance
- **Factory calibrated source:** to ensure consistency between fixtures
- **SX optical system:** double condenser optics for exceptional optical quality
- **Optional coated double condenser optics:** up to 15% more light output
- **Variable zoom optics:** sharp focus at every beam angle. Independent control of image size and focus. Focus handles on both sides
- **Electronic dimmer:** dimming without clipping or cut-out at low intensity levels; high quality smoothing

Construction

- **Made in France :** fully manufactured in Robert Juliat premises retaining complete control over all aspects of quality
- **Interchangeable lamp bases:** with 600SX (1000/1200 W tungsten) series
- **PSU:** built-in electronic flicker-free power supply for easy, plug-and-play installation
- **Power connectors:** neutriK® powerCON TRUE1 TOP IN and OUT connectors for daisy chaining
- **Silent-running cooling fans:** ideal for TV studios and opera houses
- **Electronic thermal management system:** ensures maximum performance of the system without any risk of overheating
- **Bodywork:** strong sheet metal construction for durability
- **Captive knobs and handles:** additional security when working at height or in transit
- **Spare parts and accessories:** interchangeable across the tungsten, discharge or LED ranges, reducing running costs
- **Easy access to all parts:** easy cleaning and maintenance

Picture:654SX 4C

DSEN406_654SX_4C_Preliminary - 20/09/2022 - Preliminary data
Robert Juliat reserves the right to change or alter any of the items detailed on this page, to increase or improve manufacturing techniques without prior notice.
Robert Juliat S.A.S., 32 rue de Beaumont, 60530 Fresnoy-en-Thelle - France
Telephone : +33 (0)3 44 26 51 89 - fax : +33 (0)3 44 26 90 79 - info@robertjuliat.fr
www.robertjuliat.com



ROBERT JULIAT

Source

- **Lamp type:** LED - 4 colours
- **Lumen output:** 8100 lm
- **Life:** hours (LM70)

Colours	Power *	Lumen output*	Colour temperature*	CRI* (min)
Red		1 600 lm		
Green		2 900 lm		
Blue		500 lm		
Lime		3 100 lm		

(*) manufacturer's data

Optics

Characteristics

- **Type:** Zoom
- **Beam range:** 16° to 35°
- **Focal length:** - mm

Gel filter

- **Shape:** Square
- **Standard size:** 180x180 mm (7.1x7.1 in)
- **Optional size:** 185x185 mm (7.3x7.3 in)

Gobo

- **Size:** A
- **Material:** Metal
Glass

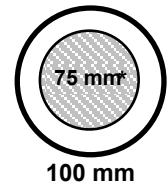

Installation and photometrics

Remote control

- **Data protocol:** USITT DMX512-A
RDM

- **Data IN connector:** 5 pins XLR male
- **Data OUT connector:** 5 pins XLR female



DMX chart:

Mode 1 (1 channels)	Mode 2 (6 channels)	Mode 3 (20 channels)	Mode 4 (20 channels)	Mode 5 (22 channels)	Mode 6 (24 channels)
Dimmer	Dimmer	Dimmer @16b	Dimmer @16b	Dimmer @16b	Dimmer @16b
	Dimmer fine	Strobe: duration + speed	Strobe: duration + speed	Strobe: duration + speed	Strobe: duration + speed
	Strobe duration	Response time	Response time	Response time	Response time
	Strobe speed	Control mode	Control mode	Control mode	Control mode
	Response time	Source type	Source type	Source type	Source type
	Control mode	Filter + adjustments	Filter + adjustments	Filter + adjustments	Filter + adjustments
		CCT + delta UV	CCT + delta UV	CCT + delta UV	CCT + delta UV
		CIE XY Colour control @16b	Hue Saturation @16b	RGB colour control @16b	RGLB colour control @16b

Dimensions and weight

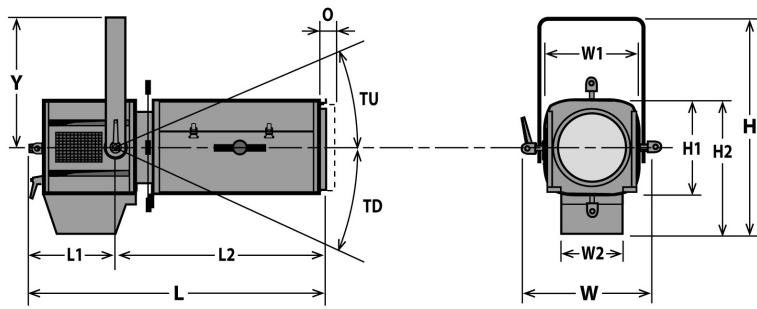

Weight: 14.1 kg (31 lbs)

Height	Length	Width	Yoke	Tilt	Option
H= 463 mm (18.2 in)	L= 696 mm (27.4 in)	W= 330 mm (13 in)	Y= 280 mm (11 in)	TU= 63°	O= 25 mm (1 in)
H1= 208 mm (8.2 in)	L1= 240 mm (9.4 in)	W1= 208 mm (8.2 in)		TD= 90°	
H2= 284 mm (11.2 in)	L2= 456 mm (18 in)	W2= 136 mm (5.4 in)			

Shipping

- **Weight :**
- **Volume :**

Installation

- **Minimum distance to illuminated surface:** 1.4 m (4.6 ft)
- **Operating position:**



Construction

- **Housing:** Steel sheet - Aluminium
- **Colour:** Black
- **Cooling:** Low noise variable fan
- **Maximum ambient temperature (Ta):** 40°C (104°F)
- **Maximum case temperature (Tc):** 60°C (140°F)
- **Total heat dissipation:** 696 BTU/h
- **Ingress Protection (IP) rating:** IP20

Electrical compatibility

- 220/230 V - 50 Hz
- 245 V - 50 Hz
- 110/120 V - 60 Hz
- 208 V - 60 Hz
- 220/230 V - 60 Hz
- 100 V - 50 Hz
- 100 V - 60 Hz
- Selector: automatic detection

Power input



- **Type:** removable power cord with Neutrik powerCON TRUE1 TOP connector (included)
- **Cable:** H07RNF 3G1.5
- **Length:** 3 m (9.8 ft)
- **Power connector:** CEE 7/7 (2P+E NF/Schuko)

Power consumption

Voltage	Frequency	Current	Power	Power factor
230 V	50 Hz	1 A	204 W	0.9
110 V	60 Hz	1.9 A	207 W	0.98
100 V	60 Hz	2.1 A	207 W	0.99

Power Supply Unit

- **PSU:** Internal - Electronic PSU - Flicker free with PFC
- **Control:** / DMX
- **Protection:** Mains: 2x 6.3A 5x20 T fuses /

Approvals







Warranty

- **Fixture: 3 years**
- See General Sales Condition on website













Model









654SX 4C	4 colours LED 200W Profile spot - 654SX 4C Sully - 16/35°
-----------------	---

Options

CAV600E	Double slot front cassette for 185x185mm accessories	
CAV600	Double slot front cassette for 180x180mm accessories	
APH 68LEDM	Double-condenser set for Led profile	
PCP1716A	16A blue 2P+E 6h IEC60309 power connector	

Accessories

D8LED	Shutter for SX LED series 4 included	
PF500M2	180x180mm metal filter holder 1 included	
SGUX	Universal "A" size gobo-holder (metal, glass, frosted glass) 1 included	
IWSX755	Drop-in iris (monoplane) with holder - Poids: 0.26 Kg	
D8	Shutter for SX series	
D8LED	Shutter for SX LED series	
PF600M2	185x185mm metal filter holder	
G500	180x180mm safety grid	
CAV600A	Double slot front cassette for 180x180mm accessories - Poids: 0.43 Kg	
CAV600AE	Double slot front cassette for 185x185mm accessories - Poids: 0.45 Kg	
APH 68LED	Double-condenser set for Led profile - Poids: 0.58 Kg	
T/650DSXCW	SULLY 115W LED compartment with display - Cool White - 3 meter power cable with CEE 7/7 (2P+T NF/SCHUKO) connector - Poids: 2.33 Kg	

T/650DSXWW	SULLY 115W LED compartment with display - Warm White - 3 meter power cable with CEE 7/7 (2P+T NF/SCHUKO) connector - Poids: 2.33 Kg	
T/650SXCW	SULLY 115W LED compartment - Cool White - 3 meter power cable with CEE 7/7 (2P+T NF/SCHUKO) connector - Poids: 2.27 Kg	
T/650SXWW	SULLY 115W LED compartment - Warm White - 3 meter power cable with CEE 7/7 (2P+T NF/SCHUKO) connector - Poids: 2.27 Kg	
VD120	120x120mm frosted glass	
FCD600	Angled yoke	
TH600	180x180mm "Top hat" (without safety cable) - ø150mm / 150mm long	
DMXcat	Bluetooth DMX/RDM Multifunction test tool - City Theatrical DMXcat®	
876	Hook clamp 40x10mm with 28mm M10 screw for Ø35 to 50mm pipes - SWL: 50Kg - Poids: 1.25 Kg	
880	Hook clamp 40x10mm with 28mm M10 screw for Ø50 to 63mm pipes - SWL: 50Kg - Poids: 1.36 Kg	
CS2	Safety cable Ø3 mm L= 600mm - SWL: 75 Kg	