

SULLY - 305LPB WW

305 - LED 115 W



- **Type:** Single lens luminaire
- **Source:** LED 115 W
- **Optics:** 150 mm Pebble lens
- **Colour temperature:** Warm white

Single lens

The multi-purpose LED spot with interchangeable lens

Providing a multi-faceted solution in a compact package, Sully 305LPB luminaire combines a high-quality 115W white LED source with a single 150 mm / 6" Pebble Convex lens which can be easily changed for a Fresnel lens. It is especially valuable in multi-purpose venues and rental companies where the interchangeable lens can be put to full use. With uniform light, very wide beam spread up to 100° and premium colour rendering, Sully Pebble will easily substitute 1000W tungsten models. It is an affordable and lightweight unit with no compromise on build quality and overall performance.

Features

- **Theatre front cassette:** no light spill to distract audiences or performers
- **Accessories holder:** double runners to hold accessories and colour filters
- **Barn door:** unique rotating barn door with 4 individually rotating blades – makes even the most difficult angle possible
- **Adjustable response time:** choice of fast or slow dimming for tungsten-like simulation - adjustment by DMX protocol
- **Ethernet-DMX node:** data IN through RJ45 connector; data OUT through DMX for daisy chaining
- **Universal data control:** compatible with DMX, RDM, Art-Net, sACN protocols
- **Remote setup:** all parameters can be adjusted by RDM protocol or by web interface
- **PWM adjustment:** choice of different PWM dimming frequencies - continuous mode available
- **Dimming parameters:** choice of square or linear dimming curves
- **Local setup (optional):** DMX address and mode, dimming curve and response time through 4-button display with automatic light switch-off
- **DMX:** 8 or 16 bit dimming, response time and strobe function
- **Focus reference:** index for easy focus reference
- **Focus adjustment:** smooth focus adjustment from rear
- **Tilt reference on hanging yoke:** index for rapid re-positioning

Optical

- **Long life:** outstanding operational lifetime expectation, no need to replace lamps, low maintenance
- **Very high quality white:** CRI>95 / TM-30 Rf>92 / TLCI>97
- **Beam shaping :** efficient barndoors in any focus position
- **Wide angle:** up to 100° from edge to edge
- **Choice of 2 lenses :** Fresnel or Pebble-Convex lens – requires a standard screwdriver only
- **Narrow beam:** up to 10° with optional extender system
- **Electronic dimmer:** dimming without clipping or cut-out at low intensity levels; high quality smoothing
- **No colour shift:** colour temperature remains the same when dimming

Construction

- **Made in France :** fully manufactured in Robert Juliat premises retaining complete control over all aspects of quality
- **PSU:** built-in electronic flicker-free power supply for easy, plug-and-play installation
- **Power connectors:** compatible powerCON® TRUE1 IN and OUT connectors for daisy chaining
- **Silent-running cooling fans:** ideal for TV studios and opera houses
- **Electronic thermal management system:** ensures maximum performance of the system without any risk of overheating
- **Bodywork:** strong sheet metal construction for durability
- **Captive knobs and handles:** additional security when working at height or in transit
- **Easy access to all parts:** easy cleaning and maintenance
- **Safety first:** front accessories safety cable attachment point

Picture:305LPB

DSEN371_305LPB_WW - 03/04/2025

Robert Juliat reserves the right to change or alter any of the items detailed on this page, to increase or improve manufacturing techniques without prior notice.

Robert Juliat S.A.S., 32 rue de Beaumont, 60530 Fresnoy-en-Thelle - France
Telephone : +33 (0)3 44 26 51 89 - info@robertjuliat.fr - www.robertjuliat.com



ROBERT JULIAT

Source (Light quality report(s) available at the end of the document)



- **Lamp type:** LED
- **Power:** 115 W

LED specifications	Power *	Lumen output*	Colour temperature*	Life*	CRI*
LED 115W WW	115 W	11 400 lm	3000K	60 000 h	98

(*) manufacturer's data

Optics

Characteristics

- **Type:** Single lens
- **Range:** 28° to 100° (Field angle)
10° to 75° configuration possible
- **Lens:** 150 mm Pebble lens

Gel filter

- **Shape:** Square
- **Standard size:** 180x180 mm (7.1x7.1")

Photometrics (Photometrics report(s) available at the end of the document)

optics: 28°-100° / Standard

• Optics @ 28°

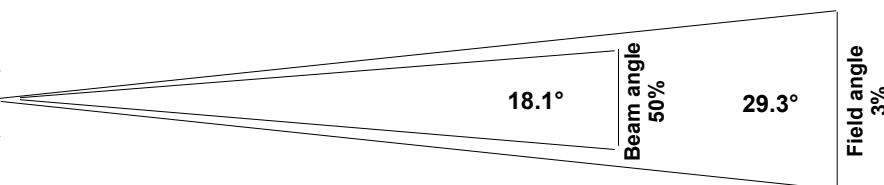
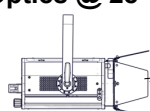

Beam intensity
21 000 cd

Field lumens
2 520 lm

Efficacy
20 lm/W

Distance	3 m	5 m	7 m	10 m	12 m	15 m
Diameter	1.6 m	2.6 m	3.7 m	5.2 m	6.3 m	7.8 m
Illumination	2 350 lux	850 lux	430 lux	220 lux	150 lux	95 lux
Distance	10 ft	15 ft	25 ft	35 ft	40 ft	50 ft
Diameter	5.2 ft	7.8 ft	13.1 ft	18.3 ft	20.9 ft	26.1 ft
Illumination	220 fc	95 fc	34 fc	18 fc	14 fc	9 fc

• Optics @ 100°

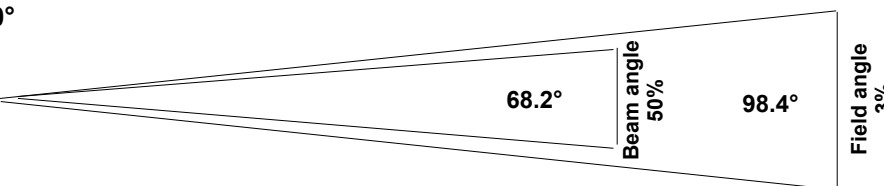
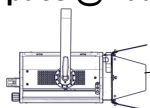

Beam intensity
5 000 cd

Field lumens
10 350 lm

Efficacy
80 lm/W

Distance	3 m	5 m	7 m	10 m	12 m	15 m
Diameter	7 m	11.6 m	16.2 m	23.2 m	27.8 m	34.8 m
Illumination	560 lux	210 lux	110 lux	51 lux	35 lux	23 lux
Distance	10 ft	15 ft	25 ft	35 ft	40 ft	50 ft
Diameter	23.2 ft	34.8 ft	57.9 ft	81.1 ft	92.7 ft	115.9 ft
Illumination	51 fc	23 fc	9 fc	5 fc	4 fc	3 fc

Remote control

- **Data protocol:** USITT DMX512-A
RDM / Art-Net / sACN

- **Data IN connector:** 5 pins XLR male + etherCON RJ45
- **Data OUT connector:** 5 pins XLR female



• DMX chart:

Mode 1 (1 channels)

Dimmer

Mode 2 (2 channels)

Dimmer
Dimmer fine

Mode 3 (5 channels)

Dimmer
Strobe duration
Strobe speed
Response time
Control mode

Mode 4 (6 channels)

Dimmer
Dimmer fine
Strobe duration
Strobe speed
Response time
Control mode

Dimensions and weight

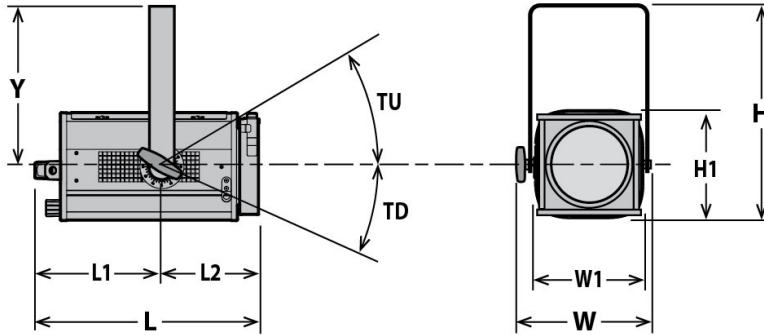

Weight: 9.5 kg (20.9 lbs)

Height	Length	Width	Yoke	Tilt
H= 387 mm (15.2 in)	L= 423 mm (16.7 in)	W= 304 mm (12 in)	Y= 283 mm (11.1 in)	TU= 90°
H1= 212 mm (8.3 in)	L1= 231 mm (9.1 in)	W1= 208 mm (8.2 in)		TD= 90°
	L2= 192 mm (7.6 in)			

Shipping

- **Weight :** 10.65 kg (23.4 lbs)
- **Volume :** .04 m³ (1.48 ft³)

Installation

- **Minimum distance to illuminated surface:** 0.2 m (0.7 ft)
- **Operating position:**

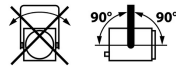

Construction

- **Housing:** Steel sheet - Aluminium
- **Colour:** Black
- **Cooling:** Low noise variable fan
- **Maximum ambient temperature (Ta):** 40°C (104°F)
- **Maximum case temperature (Tc):** 62°C (143.6°F)
- **Total heat dissipation:** 444 BTU/h
- **Ingress Protection (IP) rating:** IP20

Electrical compatibility

- 220/230 V - 50 Hz
- 245 V - 50 Hz
- 110/120 V - 60 Hz
- 208 V - 60 Hz
- 220/230 V - 60 Hz
- 100 V - 50 Hz
- 100 V - 60 Hz
- Selector: automatic detection

Power input



- **Type:** removable power cord with compatible powerCON® TRUE1 connector (included)
- **Cable:** H07RNF 3G1.5
- **Length:** 3 m (9.8 ft)
- **Power connector:** CEE 7/7 (2P+E NF/Schuko)

Power consumption

Voltage	Frequency	Current	Power	Power factor
230 V	50 Hz	0.7 A	130 W	0.81
120 V	60 Hz	1.15 A	135 W	0.98
100 V	60 Hz	1.4 A	135 W	0.96

Power Supply Unit

- **PSU:** Internal - Electronic PSU - Flicker free with PFC
- **Control:** / DMX
- **Protection:** Mains: 2x 6.3A 5x20 T fuses /
- **Power thru:** compatible powerCON® TRUE1 - Maximum of 22 units (230 V) / 12 units (120 V)

Warranty

- **Fixture: 3 years - Source: 5 years**
See General Sales Condition on website

Approvals





Acoustics

- **Noise level:** < 24 dB(A)









Model

305LPB WW	LED 115 W Single lens luminaire - 150mm Pebble - 305LPB WW Sully - Warm White
------------------	---

Options

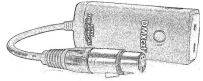
PCP1716A	16A blue 2P+E 6h IEC60309 power connector	
DISP1	Display and keyboard for local setup	

Accessories

PF500M2	180x180mm metal filter holder 1 included	
ROPT1	Narrow beam extender for 305LPB - Weight: 0.5 Kg	
CF500	4 rotating leaves on a rotating barndoor - 180x180mm (without safety cable) - Weight: 0.82 Kg	
L150 F/2	Ø150mm Fresnel lens with double slot front cassette for 180x180mm accessories - Weight: 0.8 Kg	
TH600	180x180mm "Top hat" (without safety cable) - ø150mm / 150mm long	
DMXcat	Bluetooth DMX/RDM Multifunction test tool - City Theatrical DMXcat®	
876	Hook clamp 40x10mm with 28mm M10 screw for Ø35 to 50mm pipes - SWL: 50Kg - Weight: 1.25 Kg	
880	Hook clamp 40x10mm with 28mm M10 screw for Ø50 to 63mm pipes - SWL: 50Kg - Weight: 1.36 Kg	
CS2	Safety cable Ø3 mm L= 600mm - SWL: 75 Kg	
CS5	Safety cable Ø1,5 mm L=300mm for front accessory with karabiner and quick link - SWL: 25 Kg	

• Optics @ 28°

Field lumens	Beam lumens	Efficacy	Beam intensity	CCT	Delta uv
2 520 Lm		20 Lm/W	21 000 Cd	3 050 K	

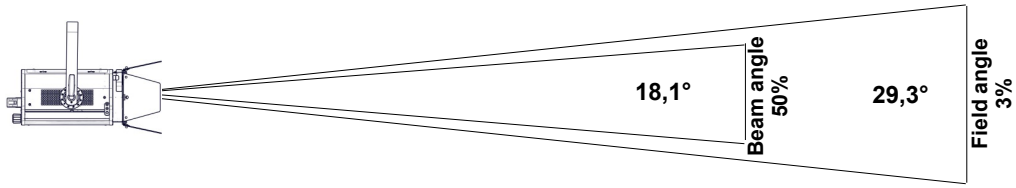

Distance	3 m	5 m	7 m	10 m	12 m	15 m
Field diameter	1,6 m	2,6 m	3,7 m	5,2 m	6,3 m	7,8 m
Illumination	2 350 lux	850 lux	430 lux	220 lux	150 lux	95 lux
Distance	10 ft	15 ft	25 ft	35 ft	40 ft	50 ft
Field diameter	5,2 ft	7,8 ft	13,1 ft	18,3 ft	20,9 ft	26,1 ft
Illumination	220 fc	95 fc	34 fc	18 fc	14 fc	9 fc

• Optics @ 60°

Field lumens	Beam lumens	Efficacy	Beam intensity	CCT	Delta uv
5 380 Lm		42 Lm/W	7 300 Cd	3 100 K	

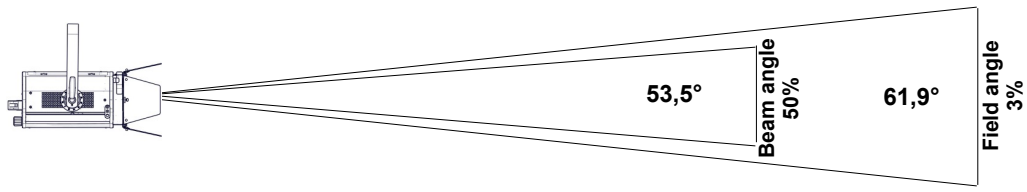

Distance	3 m	5 m	7 m	10 m	12 m	15 m
Field diameter	3,6 m	6 m	8,4 m	12 m	14,4 m	18 m
Illumination	820 lux	300 lux	150 lux	75 lux	55 lux	33 lux
Distance	10 ft	15 ft	25 ft	35 ft	40 ft	50 ft
Field diameter	12 ft	18 ft	30 ft	42 ft	48 ft	60 ft
Illumination	75 fc	33 fc	12 fc	6 fc	5 fc	3 fc

• Optics @ 100°

Field lumens	Beam lumens	Efficacy	Beam intensity	CCT	Delta uv
10 350 Lm		80 Lm/W	5 000 Cd	3 060 K	

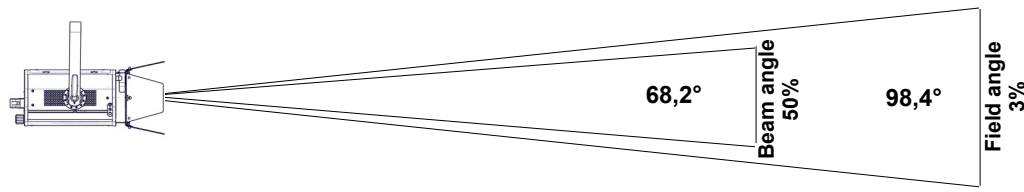

Distance	3 m	5 m	7 m	10 m	12 m	15 m
Field diameter	7 m	11,6 m	16,2 m	23,2 m	27,8 m	34,8 m
Illumination	560 lux	210 lux	110 lux	51 lux	35 lux	23 lux
Distance	10 ft	15 ft	25 ft	35 ft	40 ft	50 ft
Field diameter	23,2 ft	34,8 ft	57,9 ft	81,1 ft	92,7 ft	115,9 ft
Illumination	51 fc	23 fc	9 fc	5 fc	4 fc	3 fc

• Optics @ 10°

Field lumens	Beam lumens	Efficacy	Beam intensity	CCT	Delta uv
1 150 Lm		10 Lm/W	124 000 Cd	3 090 K	

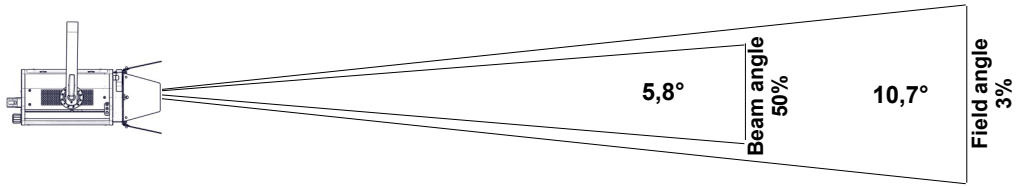

Distance	3 m	5 m	7 m	10 m	12 m	15 m
Field diameter	0,6 m	0,9 m	1,3 m	1,9 m	2,2 m	2,8 m
Illumination	14 000 lux	5 000 lux	2 550 lux	1 250 lux	870 lux	560 lux
Distance	10 ft	15 ft	25 ft	35 ft	40 ft	50 ft
Field diameter	1,9 ft	2,8 ft	4,7 ft	6,6 ft	7,5 ft	9,4 ft
Illumination	1 250 fc	560 fc	200 fc	110 fc	80 fc	50 fc

• Optics @ 30°

Field lumens	Beam lumens	Efficacy	Beam intensity	CCT	Delta uv
2 930 Lm		23 Lm/W	24 400 Cd	3 040 K	

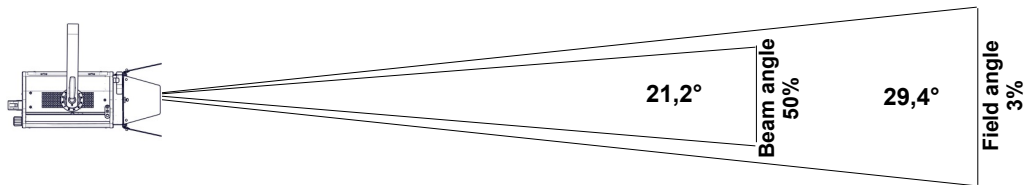

Distance	3 m	5 m	7 m	10 m	12 m	15 m
Field diameter	1,6 m	2,6 m	3,7 m	5,2 m	6,3 m	7,9 m
Illumination	2 750 lux	980 lux	500 lux	250 lux	170 lux	110 lux
Distance	10 ft	15 ft	25 ft	35 ft	40 ft	50 ft
Field diameter	5,2 ft	7,9 ft	13,1 ft	18,4 ft	21 ft	26,2 ft
Illumination	250 fc	110 fc	40 fc	20 fc	16 fc	10 fc

• Optics @ 75°

Field lumens	Beam lumens	Efficacy	Beam intensity	CCT	Delta uv
7 180 Lm		55 Lm/W	6 000 Cd	3 030 K	

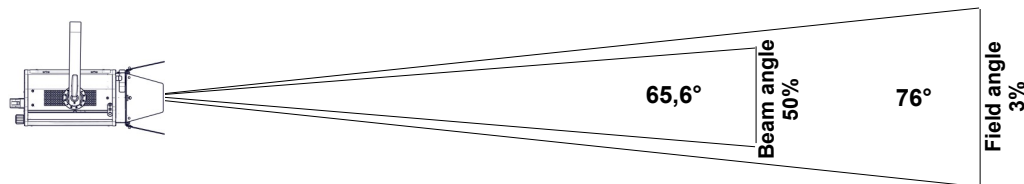

Distance	3 m	5 m	7 m	10 m	12 m	15 m
Field diameter	4,7 m	7,8 m	10,9 m	15,6 m	18,8 m	23,4 m
Illumination	670 lux	250 lux	130 lux	65 lux	42 lux	27 lux
Distance	10 ft	15 ft	25 ft	35 ft	40 ft	50 ft
Field diameter	15,6 ft	23,4 ft	39,1 ft	54,7 ft	62,5 ft	78,1 ft
Illumination	65 fc	27 fc	10 fc	5 fc	4 fc	3 fc

Light quality report

CCT	DeltaUV	CRI Ra	CRI R9	CQS Qa	TM30-18 Rf	TM30-18 Rg	TLCI	SSI [P3086]
3 090K	0.0016	96	80	95	93	99	97	85

CRI - CIE Colour Rendering Index

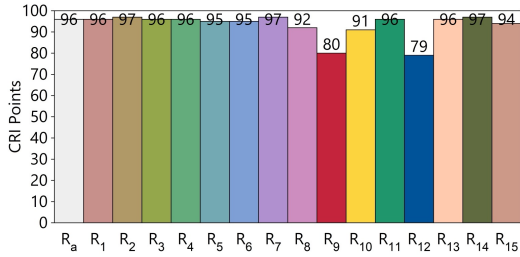

TLCI - Television Lighting Consistency Index

Test : CCT = P3086 (+0.3)
 TLCI-2012 : 97 (P3086)

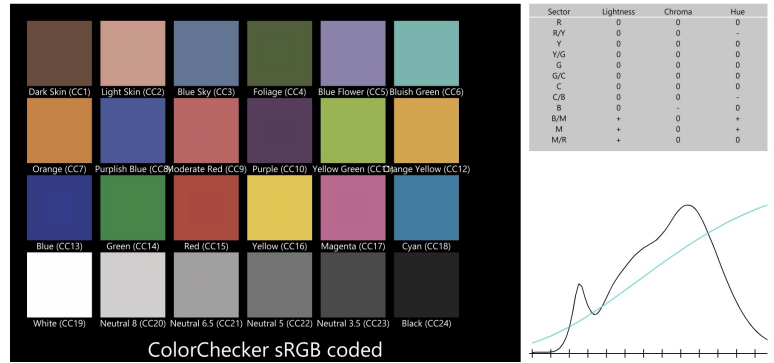

CQS - NIST Colour Quality Scale

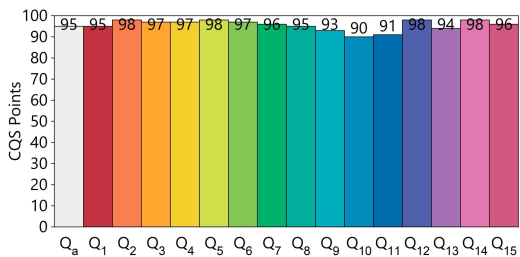

ANSI/IES TM-30-18 Colour Rendition Report

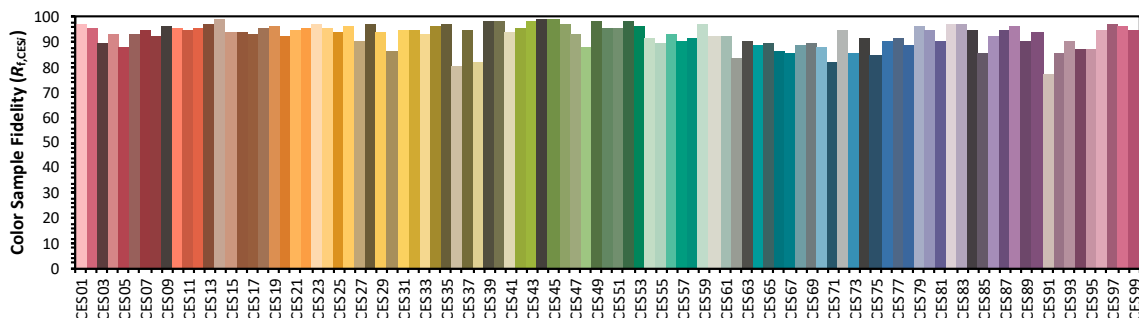
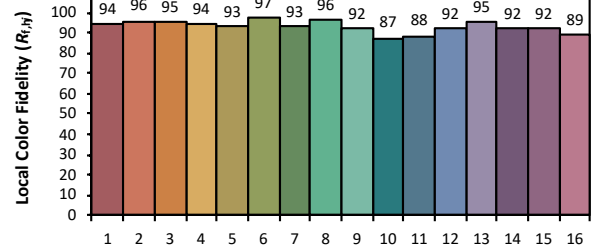
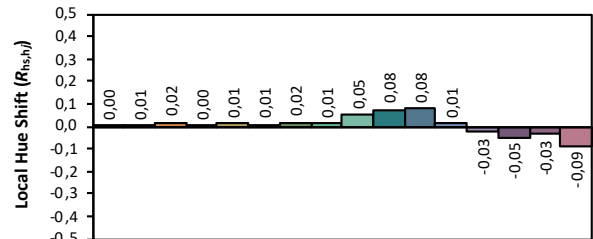
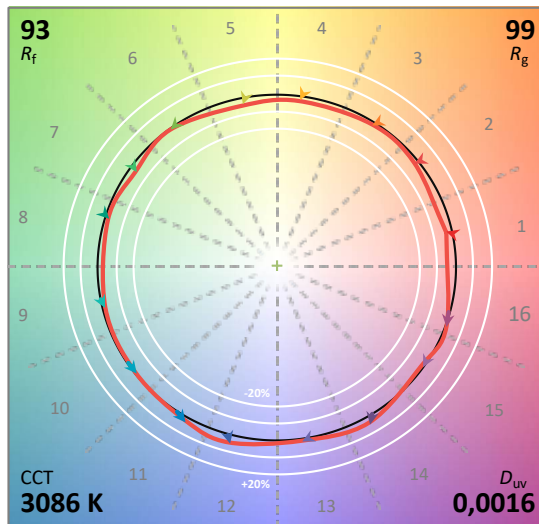
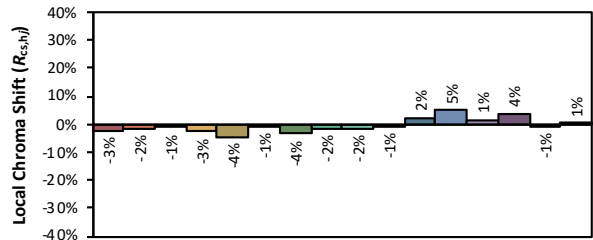
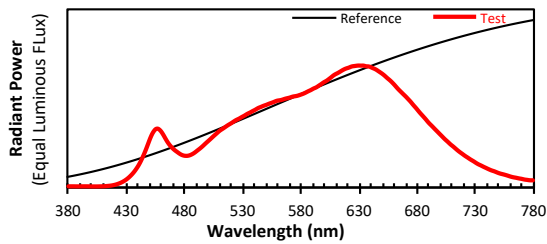

Colours are for visual orientation purposes only. Created with the IES TM-30-18 Calculator Version 2.00