

# SULLY - 305LF CW

305 - LED 115 W



- **Type:** Single lens luminaire
- **Source:** LED 115 W
- **Optics:** 150 mm Fresnel lens
- **Colour temperature:** Cool White

Single lens

## The multi-purpose LED spot with interchangeable lens

Providing a multi-faceted solution in a compact package, Sully 305LF luminaire combines a high-quality 115W white LED source with a single 150 mm / 6" Fresnel lens, which can be easily changed for a Pebble Convex lens. It is especially valuable in multi-purpose venues and rental companies where the interchangeable lens can be put to full use. With uniform light and premium colour rendering, Sully Fresnel will easily substitute 1000W tungsten models. It is an affordable and lightweight unit with no compromise on build quality and overall performance.

### Features

- **Theatre front cassette:** no light spill to distract audiences or performers
- **Accessories holder:** double runners to hold accessories and colour filters
- **Barn door:** unique rotating barn door with 4 individually rotating blades – makes even the most difficult angle possible
- **Adjustable response time:** choice of fast or slow dimming for tungsten-like simulation - adjustment by DMX protocol
- **Ethernet-DMX node:** data IN through RJ45 connector; data OUT through DMX for daisy chaining
- **Universal data control:** compatible with DMX, RDM, Art-Net, sACN protocols
- **Remote setup:** all parameters can be adjusted by RDM protocol or by web interface
- **PWM adjustment:** choice of different PWM dimming frequencies - continuous mode available
- **Dimming parameters:** choice of square or linear dimming curves
- **Local setup (optional):** DMX address and mode, dimming curve and response time through 4-button display with automatic light switch-off
- **DMX:** 8 or 16 bit dimming, response time and strobe function
- **Focus reference:** index for easy focus reference
- **Focus adjustment:** smooth focus adjustment from rear
- **Tilt reference on hanging yoke:** index for rapid re-positioning

### Optical

- **Long life:** outstanding operational lifetime expectation, no need to replace lamps, low maintenance
- **Wide angle:** up to 90° from edge to edge
- **Beam shaping :** efficient barndoors in any focus position
- **Choice of 2 lenses :** Fresnel or Pebble-Convex lens – requires a standard screwdriver only
- **Electronic dimmer:** dimming without clipping or cut-out at low intensity levels; high quality smoothing
- **No colour shift:** colour temperature remains the same when dimming

### Construction

- **Made in France :** fully manufactured in Robert Juliat premises retaining complete control over all aspects of quality
- **PSU:** built-in electronic flicker-free power supply for easy, plug-and-play installation
- **Power connectors:** compatible powerCON® TRUE1 IN and OUT connectors for daisy chaining
- **Silent-running cooling fans:** ideal for TV studios and opera houses
- **Electronic thermal management system:** ensures maximum performance of the system without any risk of overheating
- **Bodywork:** strong sheet metal construction for durability
- **Captive knobs and handles:** additional security when working at height or in transit
- **Easy access to all parts:** easy cleaning and maintenance
- **Safety first:** front accessories safety cable attachment point

Picture:305LF

DSEN370\_305LF\_CW - 03/04/2025

Robert Juliat reserves the right to change or alter any of the items detailed on this page, to increase or improve manufacturing techniques without prior notice.

Robert Juliat S.A.S., 32 rue de Beaumont, 60530 Fresnoy-en-Thelle - France  
Telephone : +33 (0)3 44 26 51 89 - info@robertjuliat.fr - www.robertjuliat.com



ROBERT JULIAT

**Source** (Light quality report(s) available at the end of the document)

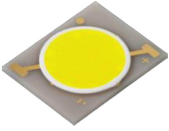

- **Lamp type:** LED
- **Power:** 115 W

LED specifications	Power *	Lumen output*	Colour temperature*	CRI*
LED 115W CW	115 W	14 300 lm	5700K	93

(\*) manufacturer's data

**Optics**

**Characteristics**

- **Type:** Single lens
- **Range:** 7° to 50° (Beam angle)
- **Lens:** 150 mm Fresnel lens

**Gel filter**

- **Shape:** Square
- **Standard size:** 180x180 mm (7.1x7.1")

**Photometrics** (Photometrics report(s) available at the end of the document)

optics: 7°-50° / Standard

• **Optics @ 7°**

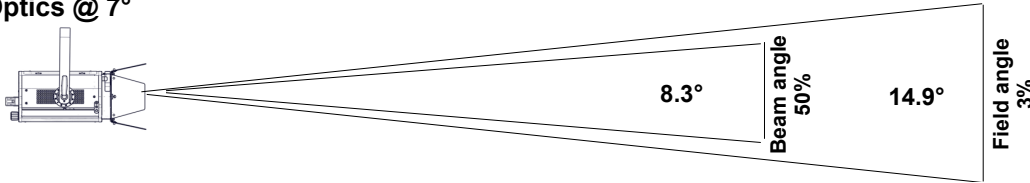

**Beam intensity**  
123 100 cd

**Field lumens**  
2 710 lm

**Efficacy**  
21 lm/W

<b>Distance</b>	3 m	5 m	7 m	10 m	12 m	15 m
<b>Diameter</b>	0.8 m	1.3 m	1.8 m	2.6 m	3.1 m	3.9 m
<b>Illumination</b>	14 000 lux	4 950 lux	2 550 lux	1 250 lux	860 lux	550 lux
<b>Distance</b>	10 ft	15 ft	25 ft	35 ft	40 ft	50 ft
<b>Diameter</b>	2.6 ft	3.9 ft	6.5 ft	9.2 ft	10.5 ft	13.1 ft
<b>Illumination</b>	1 250 fc	550 fc	200 fc	110 fc	80 fc	50 fc

• **Optics @ 50°**

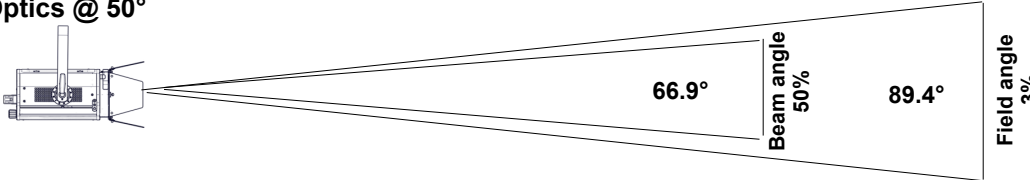

**Beam intensity**  
9 500 cd

**Field lumens**  
10 420 lm

**Efficacy**  
81 lm/W

<b>Distance</b>	3 m	5 m	7 m	10 m	12 m	15 m
<b>Diameter</b>	5.9 m	9.9 m	13.9 m	19.8 m	23.7 m	29.7 m
<b>Illumination</b>	1 100 lux	390 lux	200 lux	100 lux	70 lux	43 lux
<b>Distance</b>	10 ft	15 ft	25 ft	35 ft	40 ft	50 ft
<b>Diameter</b>	19.8 ft	29.7 ft	49.5 ft	69.3 ft	79.2 ft	99 ft
<b>Illumination</b>	100 fc	43 fc	16 fc	8 fc	6 fc	4 fc

**Remote control**

- **Data protocol:** USITT DMX512-A  
RDM / Art-Net / sACN

- **Data IN connector:** 5 pins XLR male + etherCON RJ45
- **Data OUT connector:** 5 pins XLR female



• **DMX chart:**

Mode 1 (1 channels)	Mode 2 (2 channels)	Mode 3 (5 channels)	Mode 4 (6 channels)
Dimmer	Dimmer Dimmer fine	Dimmer Strobe duration Strobe speed Response time Control mode	Dimmer Dimmer fine Strobe duration Strobe speed Response time Control mode

## Dimensions and weight

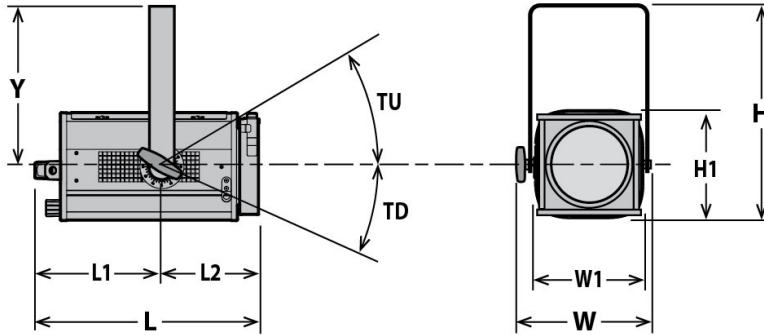

**Weight:** 9.15 kg (20.1 lbs)

Height	Length	Width	Yoke	Tilt
H= 387 mm (15.2 in)	L= 423 mm (16.7 in)	W= 304 mm (12 in)	Y= 283 mm (11.1 in)	TU= 90°
H1= 212 mm (8.3 in)	L1= 231 mm (9.1 in)	W1= 208 mm (8.2 in)		TD= 90°
	L2= 192 mm (7.6 in)			

## Shipping

- **Weight :** 10.3 kg (22.7 lbs)
- **Volume :** .04 m<sup>3</sup> (1.48 ft<sup>3</sup>)

## Installation

- **Minimum distance to illuminated surface:** 0.2 m ( 0.7 ft )
- **Operating position:**



## Construction

- **Housing:** Steel sheet - Aluminium
- **Colour:** Black
- **Cooling:** Low noise variable fan
- **Maximum ambient temperature (Ta):** 40°C (104°F)
- **Maximum case temperature (Tc):** 62°C (143.6°F)
- **Total heat dissipation:** 444 BTU/h
- **Ingress Protection (IP) rating:** IP20

## Electrical compatibility

- 220/230 V - 50 Hz
- 245 V - 50 Hz
- 110/120 V - 60 Hz
- 208 V - 60 Hz
- 220/230 V - 60 Hz
- 100 V - 50 Hz
- 100 V - 60 Hz
- Selector: automatic detection

## Power input



- **Type:** removable power cord with compatible powerCON® TRUE1 connector (included)
- **Cable:** H07RNF 3G1.5
- **Length:** 3 m (9.8 ft)
- **Power connector:** CEE 7/7 (2P+E NF/Schuko)

## Power consumption

Voltage	Frequency	Current	Power	Power factor
230 V	50 Hz	0.7 A	130 W	0.81
120 V	60 Hz	1.15 A	135 W	0.98
100 V	60 Hz	1.4 A	135 W	0.96

## Power Supply Unit

- **PSU:** Internal - Electronic PSU - Flicker free with PFC
- **Control:** / DMX
- **Protection:** Mains: 2x 6.3A 5x20 T fuses /
- **Power thru:** compatible powerCON® TRUE1 - Maximum of 22 units (230 V) / 12 units (120 V)

## Warranty

- **Fixture: 3 years - Source: 5 years**  
See General Sales Condition on website

## Approvals



## Acoustics

- **Noise level:** < 24 dB(A)







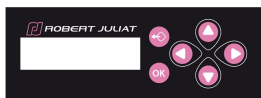

## Model

<b>305LF CW</b>	LED 115 W Single lens luminaire - 150mm Fresnel - 305LF CW Sully - Cool White
-----------------	---

## Options

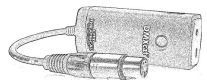
<b>PCP1716A</b>	16A blue 2P+E 6h IEC60309 power connector	
<b>DISP1</b>	Display and keyboard for local setup	

## Accessories

<b>PF500M2</b>	180x180mm metal filter holder <b>1 included</b>	
<b>CF500</b>	4 rotating leaves on a rotating barndoor - 180x180mm ( without safety cable) - Weight: 0.82 Kg	
<b>L150 PB/2</b>	Ø150mm Pebble convex lens with double slot front cassette for 180x180mm accessories - Weight: 1.25 Kg	
<b>TH600</b>	180x180mm "Top hat" (without safety cable) - ø150mm / 150mm long	
<b>DMXcat</b>	Bluetooth DMX/RDM Multifunction test tool - City Theatrical DMXcat®	
<b>876</b>	Hook clamp 40x10mm with 28mm M10 screw for Ø35 to 50mm pipes - SWL: 50Kg - Weight: 1.25 Kg	
<b>880</b>	Hook clamp 40x10mm with 28mm M10 screw for Ø50 to 63mm pipes - SWL: 50Kg - Weight: 1.36 Kg	
<b>CS2</b>	Safety cable Ø3 mm L= 600mm - SWL: 75 Kg	
<b>CS5</b>	Safety cable Ø1,5 mm L=300mm for front accessory with karabiner and quick link - SWL: 25 Kg	

• Optics @ 7°

Field lumens	Beam lumens	Efficacy	Beam intensity	CCT	Delta uv
2 710 Lm		21 Lm/W	123 100 Cd	5 440 K	

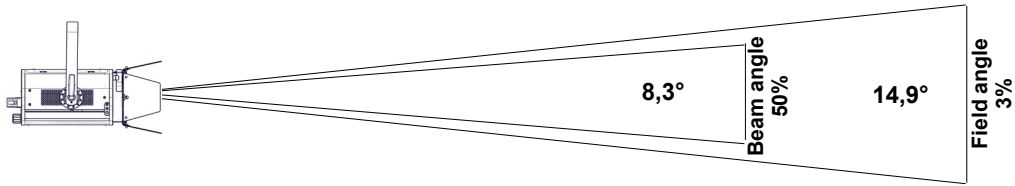

Distance	3 m	5 m	7 m	10 m	12 m	15 m
Field diameter	0,8 m	1,3 m	1,8 m	2,6 m	3,1 m	3,9 m
Illumination	14 000 lux	4 950 lux	2 550 lux	1 250 lux	860 lux	550 lux
Distance	10 ft	15 ft	25 ft	35 ft	40 ft	50 ft
Field diameter	2,6 ft	3,9 ft	6,5 ft	9,2 ft	10,5 ft	13,1 ft
Illumination	1 250 fc	550 fc	200 fc	110 fc	80 fc	50 fc

• Optics @ 35°

Field lumens	Beam lumens	Efficacy	Beam intensity	CCT	Delta uv
6 390 Lm		50 Lm/W	16 800 Cd	5 440 K	

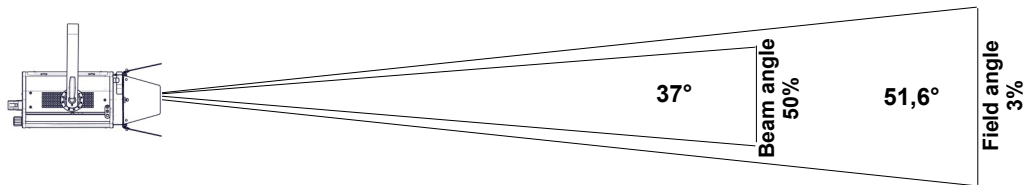

Distance	3 m	5 m	7 m	10 m	12 m	15 m
Field diameter	2,9 m	4,8 m	6,8 m	9,7 m	11,6 m	14,5 m
Illumination	1 900 lux	680 lux	350 lux	170 lux	120 lux	75 lux
Distance	10 ft	15 ft	25 ft	35 ft	40 ft	50 ft
Field diameter	9,7 ft	14,5 ft	24,2 ft	33,8 ft	38,7 ft	48,3 ft
Illumination	170 fc	75 fc	27 fc	14 fc	11 fc	7 fc

• Optics @ 50°

Field lumens	Beam lumens	Efficacy	Beam intensity	CCT	Delta uv
10 420 Lm		81 Lm/W	9 500 Cd	5 470 K	

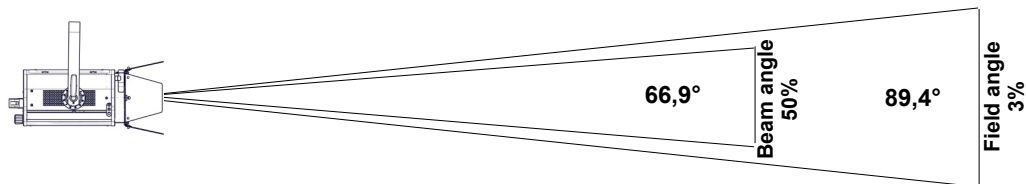

Distance	3 m	5 m	7 m	10 m	12 m	15 m
Field diameter	5,9 m	9,9 m	13,9 m	19,8 m	23,7 m	29,7 m
Illumination	1 100 lux	390 lux	200 lux	100 lux	70 lux	43 lux
Distance	10 ft	15 ft	25 ft	35 ft	40 ft	50 ft
Field diameter	19,8 ft	29,7 ft	49,5 ft	69,3 ft	79,2 ft	99 ft
Illumination	100 fc	43 fc	16 fc	8 fc	6 fc	4 fc

# Light quality report

CCT	DeltaUV	CRI Ra	CRI R9	CQS Qa	TM30-18 Rf	TM30-18 Rg	TLCI	SSI [D5659]
5 660K	0.0030	93	60	93	92	102	90	71

## CRI - CIE Colour Rendering Index

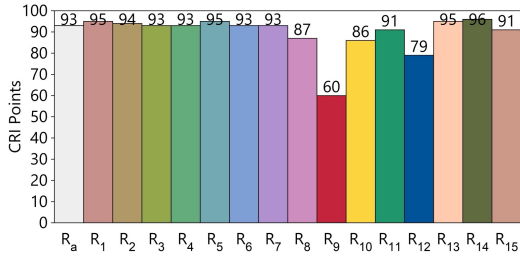

## TLCI - Television Lighting Consistency Index

Test : CCT = D5659 (0.0)  
 TLCI-2012 : 90 (D5659)

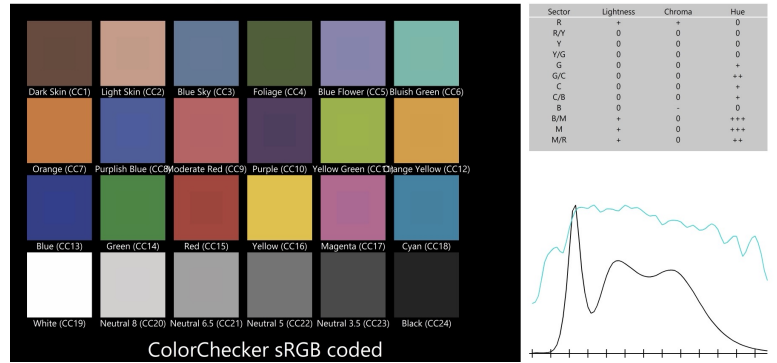

## CQS - NIST Colour Quality Scale

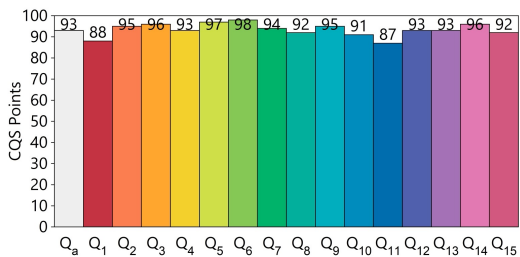

## ANSI/IES TM-30-18 Colour Rendition Report

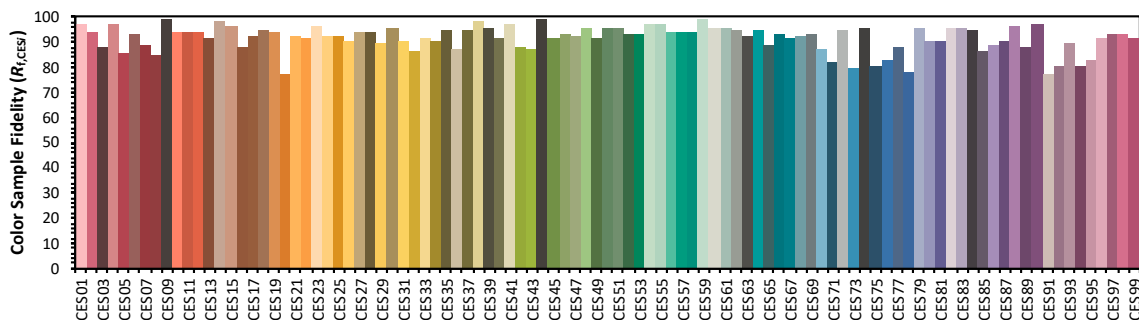
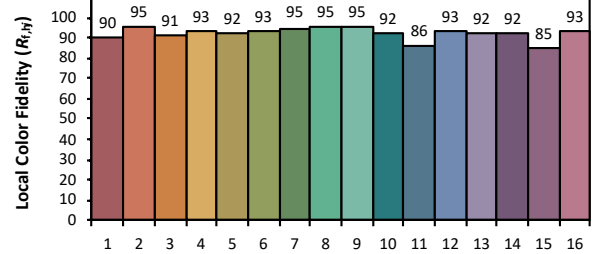
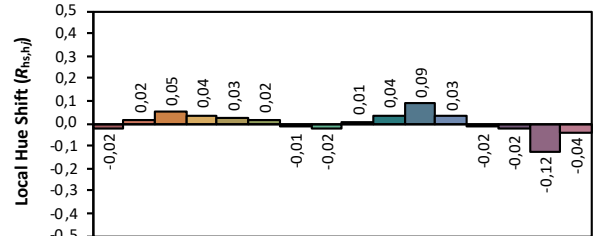
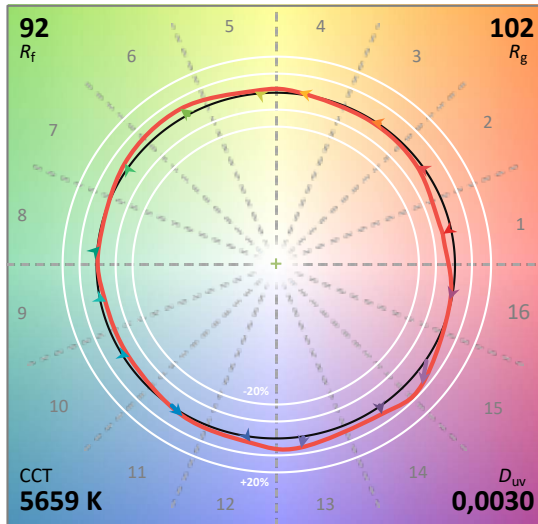
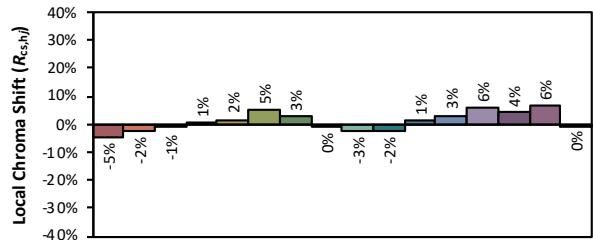
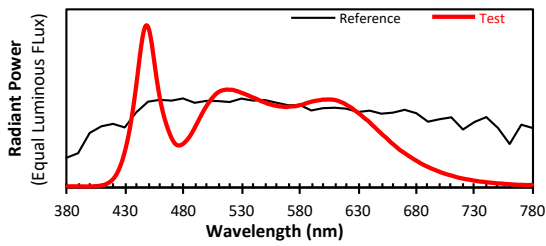

Colours are for visual orientation purposes only. Created with the IES TM-30-18 Calculator Version 2.00