

TIBO HE - 553 WW

550 - LED 115 W



- **Type:** Profile spot
- **Source:** LED 115 W
- **Optics:** 30° to 45° zoom
15° to 35° configuration possible
- **Colour temperature:** Warm white

Profile spot

A High Efficiency LED engine housed within a compact and versatile profile

Tibo HE 553 is a product evolution of the original 75 W LED Tibo 533 model. Tibo HE (High Efficiency) is a new mighty compact profile spot featuring a 115 W white LED engine. It offers twice as much light output and quality. Tibo HE delivers a very high CRI and guarantees a light output that far exceeds 1000 W tungsten luminaires and nearly matches that of 1200 W tungsten models. The power supply is now integrated into the unit to make it really compact and easier to incorporate into a design vision. Its versatile optical design remains unchanged and still offers two different zoom ranges in one single unit – from 15/35° to 30/45° - which makes Tibo HE fitting into into any application, from architectural to event applications as well as traditional entertainment lighting.

Features

- **Shutter gate:** 4 shutters. Remove shutters for easy maintenance or tuck fully inside gate for secure transport
- **Universal gobo holder:** m-size, glass and metal gobos
- **Continuous 360° rotation of the fixture:** adjustment of the projected image is always possible
- **Adjustable response time:** choice of fast or slow dimming for tungsten-like simulation - adjustment by DMX protocol
- **Universal data control:** compatible with DMX, RDM, Art-Net, sACN protocols
- **Remote setup:** all parameters can be adjusted by RDM protocol or by web interface
- **PWM adjustment:** choice of different PWM dimming frequencies - continuous mode available
- **Dimming parameters:** choice of square or linear dimming curves
- **DMX:** 8 or 16 bit dimming, response time and strobe function
- **Tilt reference on hanging yoke:** index for rapid re-positioning

Optical

- **Long life:** outstanding operational lifetime expectation, no need to replace lamps, low maintenance
- **Efficient fixture:** up to 55 lm/W
- **Very high quality white:** CRI>95 / TM-30 Rf>92 / TLCI>97
- **Coated double condenser optical system:** ensures optimal light transmission
- **Variable zoom optics:** sharp focus at every beam angle. Independent control of image size and focus. Focus handles on both sides
- **Two different zoom ranges in one single unit:** 30/45° or 15/35° by adding/removing one lens - save on material costs and storage of separate lens tubes
- **Electronic dimmer:** dimming without clipping or cut-out at low intensity levels; high quality smoothing
- **No colour shift:** colour temperature remains the same when dimming

Construction

- **Made in France :** fully manufactured in Robert Juliat premises retaining complete control over all aspects of quality
- **PSU:** built-in electronic flicker-free power supply for easy, plug-and-play installation
- **Power connectors:** compatible powerCON® TRUE1 IN and OUT connectors for daisy chaining
- **Silent-running cooling fans:** ideal for TV studios and opera houses
- **Electronic thermal management system:** ensures maximum performance of the system without any risk of overheating
- **Bodywork:** die cast aluminium housing
- **Captive knobs and handles:** additional security when working at height or in transit
- **Easy access to all lenses without tool:** easy cleaning of all lenses (including into the lamp house)

Picture:553

DSEN365_553_WW - 08/04/2026

Robert Juliat reserves the right to change or alter any of the items detailed on this page, to increase or improve manufacturing techniques without prior notice.

Robert Juliat S.A.S., 32 rue de Beaumont, 60530 Fresnoy-en-Thelle - France
Telephone : +33 (0)3 44 26 51 89 - info@robertjuliat.fr - www.robertjuliat.com



ROBERT JULIAT

Source (Light quality report(s) available at the end of the document)

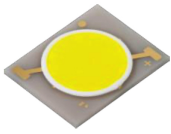

- **Lamp type:** LED
- **Power:** 115 W

LED specifications	Power *	Lumen output*	Colour temperature*	Life*	CRI*
LED 115W WW	115 W	11 400 lm	3000K	60 000 h	98

(*) manufacturer's data - Life reference: L80B10

Optics

Characteristics

- **Type:** Zoom
- **Range:** 30° to 45° (Field angle)
15° to 35° configuration possible
- **Focal length:** 69 - 98 mm

Gel filter

- **Shape:** Square
- **Standard size:** 138x138 mm (5.4x5.4 in)

Gobo

- **Size:** M
- **Material:** Metal
Glass

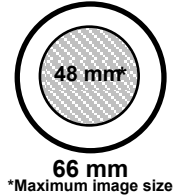

Photometrics (Photometrics report(s) available at the end of the document)

optics: 30°-45° / Standard

• **Optics @ 30°**

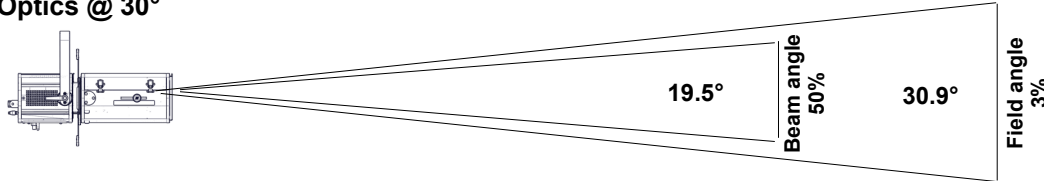

Beam intensity
55 400 cd

Field lumens
6 930 lm

Efficacy
53 lm/W

Distance	3 m	5 m	7 m	10 m	12 m	15 m
Diameter	1.7 m	2.8 m	3.9 m	5.5 m	6.6 m	8.3 m
Illumination	6 200 lux	2 250 lux	1 150 lux	560 lux	390 lux	250 lux
Distance	10 ft	15 ft	25 ft	35 ft	40 ft	50 ft
Diameter	5.5 ft	8.3 ft	13.8 ft	19.3 ft	22.1 ft	27.6 ft
Illumination	560 fc	250 fc	90 fc	46 fc	35 fc	23 fc

• **Optics @ 45°**

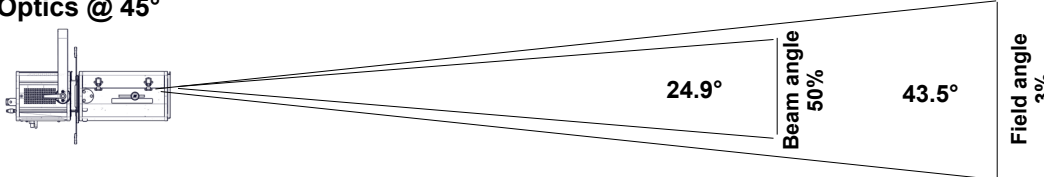

Beam intensity
33 100 cd

Field lumens
7 230 lm

Efficacy
56 lm/W

Distance	3 m	5 m	7 m	10 m	12 m	15 m
Diameter	2.4 m	4 m	5.6 m	8 m	9.6 m	12 m
Illumination	3 700 lux	1 350 lux	680 lux	340 lux	230 lux	150 lux
Distance	10 ft	15 ft	25 ft	35 ft	40 ft	50 ft
Diameter	8 ft	12 ft	19.9 ft	27.9 ft	31.9 ft	39.9 ft
Illumination	340 fc	150 fc	55 fc	28 fc	21 fc	14 fc

Remote control

- **Data protocol:** USITT DMX512-A
RDM / Art-Net / sACN

- **Data IN connector:** 5 pins XLR male + etherCON RJ45
- **Data OUT connector:** 5 pins XLR female



• **DMX chart:**

Mode 1 (1 channels)	Mode 2 (2 channels)	Mode 3 (5 channels)	Mode 4 (6 channels)
Dimmer	Dimmer Dimmer fine	Dimmer Strobe duration Strobe speed Response time Control mode	Dimmer Dimmer fine Strobe duration Strobe speed Response time Control mode

Dimensions and weight

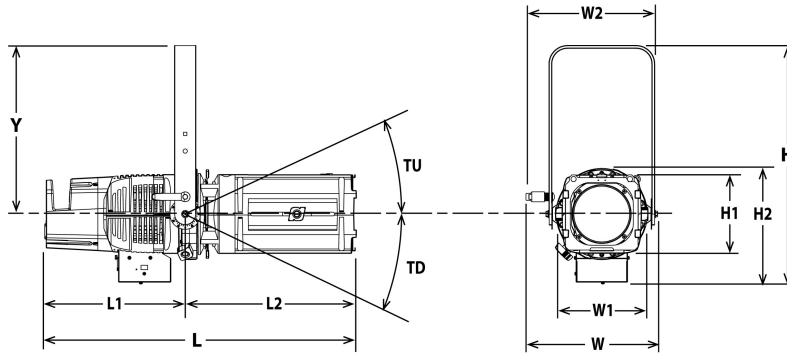

Weight: 10.2 kg (22.4 lbs)

Height	Length	Width	Yoke	Tilt
H= 454 mm (17.9 in)	L= 594 mm (23.4 in)	W= 251 mm (9.9 in)	Y= 301 mm (11.9 in)	TD= 90°
H1= 150 mm (5.9 in)	L1= 268 mm (10.6 in)	W1= 150 mm (5.9 in)		
H2= 218 mm (8.6 in)	L2= 326 mm (12.8 in)			

Shipping

- **Weight :** 11.4 kg (25.1 lbs)
- **Volume :** .06 m³ (1.98 ft³)

Installation

- **Minimum distance to illuminated surface:** 0.5 m (1.6 ft)
- **Operating position:**

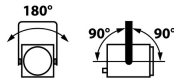

Construction

- **Housing:** Die cast aluminium
- **Colour:** Black
- **Cooling:** Low noise variable fan
- **Maximum ambient temperature (Ta):** 40°C (104°F)
- **Maximum case temperature (Tc):** °C (°F)
- **Total heat dissipation:** 444 BTU/h
- **Ingress Protection (IP) rating:** IP20

Electrical compatibility

- 220/230 V - 50 Hz
- 245 V - 50 Hz
- 110/120 V - 60 Hz
- 208 V - 60 Hz
- 220/230 V - 60 Hz
- 100 V - 50 Hz
- 100 V - 60 Hz
- Selector: automatic detection

Power input



- **Type:** removable power cord with compatible powerCON® TRUE1 connector (included)
- **Cable:** H07RNF 3G1.5
- **Length:** 3 m (9.8 ft)
- **Power connector:** CEE 7/7 (2P+E NF/Schuko)

Power consumption

Voltage	Frequency	Current	Power	Power factor
230 V	50 Hz	0.7 A	130 W	0.81
120 V	60 Hz	1.2 A	135 W	0.94
100 V	60 Hz	1.4 A	135 W	0.93

Power Supply Unit

- **PSU:** Internal - Electronic PSU - Flicker free with PFC
- **Control:** / DMX
- **Protection:** Mains: 2x 6.3A 5x20 T fuses /
- **Power thru:** compatible powerCON® TRUE1 - Maximum of 22 units (230 V) / 11 units (120 V)

Approvals



Warranty

- **Fixture: 3 years - Source: 5 years**
See General Sales Condition on website



Acoustics

- **Noise level:** < 23,5 dB(A)











Model

553 WW	LED 115 W Profile spot - 553 WW Tibo HE - Warm White - 30/45°
---------------	---

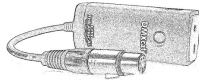
Options

PCP1716A	16A blue 2P+E 6h IEC60309 power connector	
T-RAL9010	White housing (RAL 9010)	

Accessories

D4	Shutter for Tibo series 4 included	
PF100M	135x135mm metal filter holder 1 included	
Fusion/RJ	Madrix Radar (RDM monitoring): Fusion RJ licence - access to all RDM parameters of RJ fixtures 1 included	
IS500/2	Drop-in iris (monoplane) with holder	
SGUT	Universal "M" size gobo-holder (metal, glass, frosted glass)	
DMXcat	Bluetooth DMX/RDM Multifunction test tool - City Theatrical DMXcat®	
Fusion/L	Madrix Radar (RDM monitoring): Fusion Large licence - up to 4096 non-RJ RDM fixtures - USB dongle included	
Fusion/M	Madrix Radar (RDM monitoring): Fusion Medium licence - up to 512 non-RJ RDM fixtures - USB dongle included	
Fusion/S	Madrix Radar (RDM monitoring): Fusion Small licence - up to 64 non-RJ RDM fixtures - USB dongle included	
872	Doughty "Twenty clamp" with M10 screw/nut for Ø48 to 51mm pipes - SWL: 20Kg - TÜV approved - Weight: 0.25 Kg	
878	Hook clamp 25x6mm with 23mm M10 screw for Ø35 to 50mm pipes - SWL: 11Kg - Weight: 0.46 Kg	
CS2	Safety cable Ø3 mm L= 600mm - SWL: 75 Kg	

• Optics @ 30°

Field lumens	Beam lumens	Efficacy	Beam intensity	CCT	Delta uv
6 930 Lm	3 890 Lm	53 Lm/W	55 400 Cd	3 060 K	0.0014

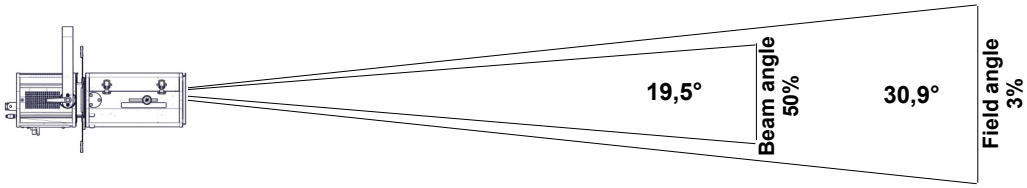

Distance	3 m	5 m	7 m	10 m	12 m	15 m
Field diameter	1,7 m	2,8 m	3,9 m	5,5 m	6,6 m	8,3 m
Illumination	6 200 lux	2 250 lux	1 150 lux	560 lux	390 lux	250 lux
Distance	10 ft	15 ft	25 ft	35 ft	40 ft	50 ft
Field diameter	5,5 ft	8,3 ft	13,8 ft	19,3 ft	22,1 ft	27,6 ft
Illumination	560 fc	250 fc	90 fc	46 fc	35 fc	23 fc

• Optics @ 38°

Field lumens	Beam lumens	Efficacy	Beam intensity	CCT	Delta uv
7 040 Lm	3 950 Lm	54 Lm/W	43 800 Cd	3 070 K	0.0016

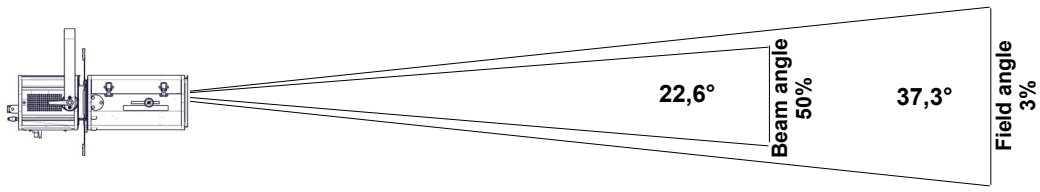

Distance	3 m	5 m	7 m	10 m	12 m	15 m
Field diameter	2 m	3,4 m	4,7 m	6,8 m	8,1 m	10,1 m
Illumination	4 900 lux	1 800 lux	900 lux	440 lux	310 lux	200 lux
Distance	10 ft	15 ft	25 ft	35 ft	40 ft	50 ft
Field diameter	6,8 ft	10,1 ft	16,9 ft	23,6 ft	27 ft	33,8 ft
Illumination	440 fc	200 fc	75 fc	36 fc	28 fc	18 fc

• Optics @ 45°

Field lumens	Beam lumens	Efficacy	Beam intensity	CCT	Delta uv
7 230 Lm	4 060 Lm	56 Lm/W	33 100 Cd	3 060 K	0.0015

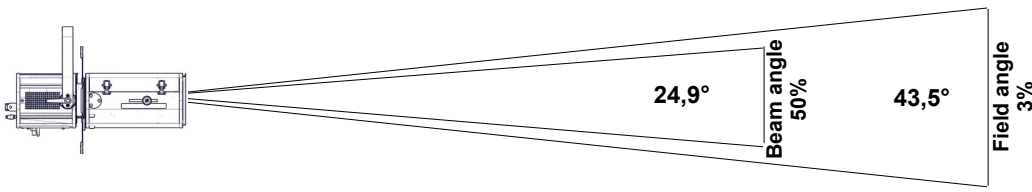

Distance	3 m	5 m	7 m	10 m	12 m	15 m
Field diameter	2,4 m	4 m	5,6 m	8 m	9,6 m	12 m
Illumination	3 700 lux	1 350 lux	680 lux	340 lux	230 lux	150 lux
Distance	10 ft	15 ft	25 ft	35 ft	40 ft	50 ft
Field diameter	8 ft	12 ft	19,9 ft	27,9 ft	31,9 ft	39,9 ft
Illumination	340 fc	150 fc	55 fc	28 fc	21 fc	14 fc

• Optics @ 15°

Field lumens	Beam lumens	Efficacy	Beam intensity	CCT	Delta uv
6 810 Lm	3 820 Lm	52 Lm/W	153 300 Cd	3 070 K	0.0015

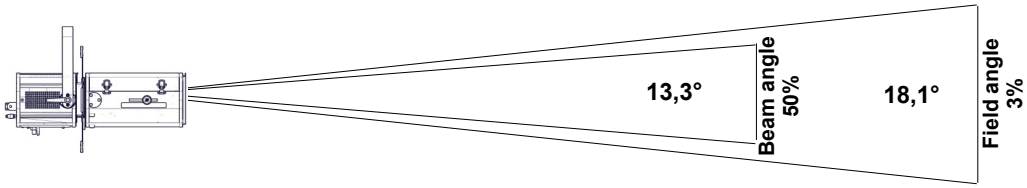

Distance	3 m	5 m	7 m	10 m	12 m	15 m
Field diameter	1 m	1,6 m	2,2 m	3,2 m	3,8 m	4,8 m
Illumination	17 500 lux	6 200 lux	3 150 lux	1 550 lux	1 100 lux	690 lux
Distance	10 ft	15 ft	25 ft	35 ft	40 ft	50 ft
Field diameter	3,2 ft	4,8 ft	8 ft	11,1 ft	12,7 ft	15,9 ft
Illumination	1 550 fc	690 fc	250 fc	130 fc	100 fc	65 fc

• Optics @ 25°

Field lumens	Beam lumens	Efficacy	Beam intensity	CCT	Delta uv
6 680 Lm	3 860 Lm	53 Lm/W	80 400 Cd	3 050 K	0.0016

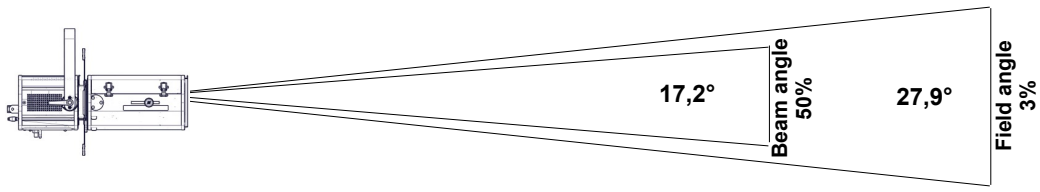

Distance	3 m	5 m	7 m	10 m	12 m	15 m
Field diameter	1,5 m	2,5 m	3,5 m	5 m	6 m	7,5 m
Illumination	9 000 lux	3 250 lux	1 650 lux	810 lux	560 lux	360 lux
Distance	10 ft	15 ft	25 ft	35 ft	40 ft	50 ft
Field diameter	5 ft	7,5 ft	12,4 ft	17,4 ft	19,9 ft	24,8 ft
Illumination	810 fc	360 fc	130 fc	70 fc	55 fc	33 fc

• Optics @ 35°

Field lumens	Beam lumens	Efficacy	Beam intensity	CCT	Delta uv
6 950 Lm	3 910 Lm	54 Lm/W	61 200 Cd	3 050 K	0.0016

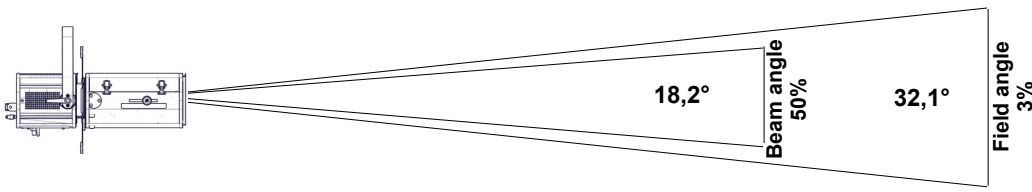

Distance	3 m	5 m	7 m	10 m	12 m	15 m
Field diameter	1,7 m	2,9 m	4 m	5,8 m	6,9 m	8,6 m
Illumination	6 900 lux	2 450 lux	1 250 lux	620 lux	430 lux	280 lux
Distance	10 ft	15 ft	25 ft	35 ft	40 ft	50 ft
Field diameter	5,8 ft	8,6 ft	14,4 ft	20,1 ft	23 ft	28,8 ft
Illumination	620 fc	280 fc	100 fc	50 fc	39 fc	25 fc

Light quality report

CCT	DeltaUV	CRI Ra	CRI R9	CQS Qa	TM30-18 Rf	TM30-18 Rg	TLCI	SSI [P3000]
2980K	0.0014	96	81	95	92	98	97	85

CRI - CIE Colour Rendering Index

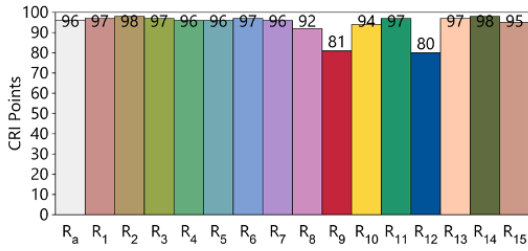

TLCI - Television Lighting Consistency Index

Test : CCT = P2984 (+0.3)
 TLCI-2012 : 97 (P2984)

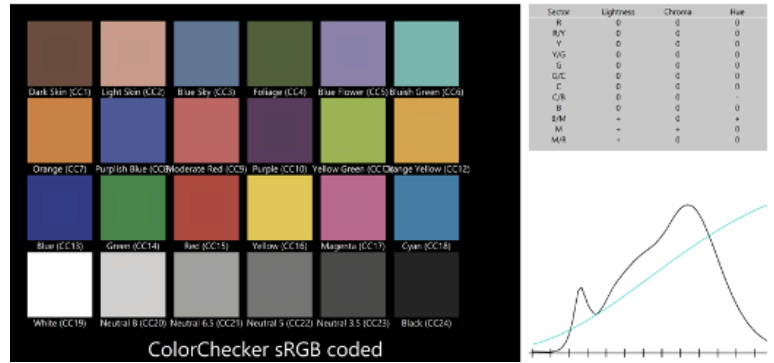

CQS - NIST Colour Quality Scale

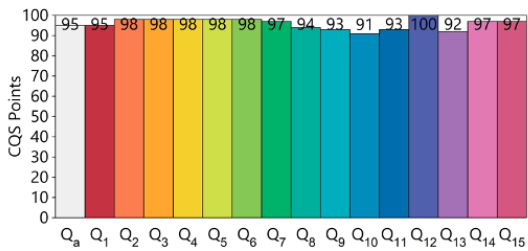

ANSI/IES TM-30-18 Colour Rendition Report

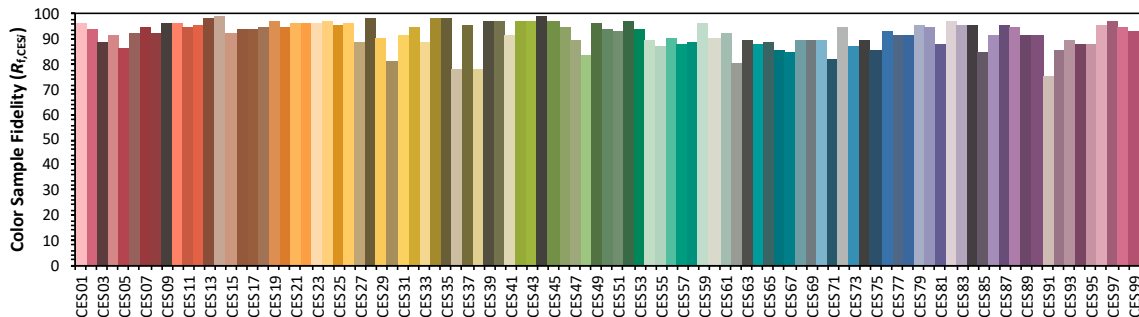
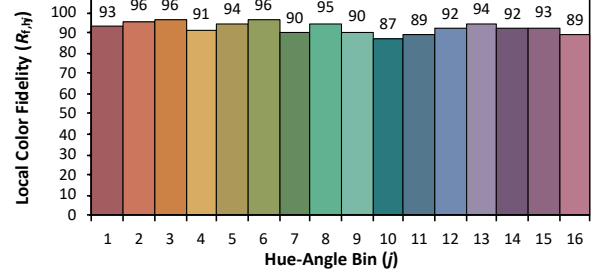
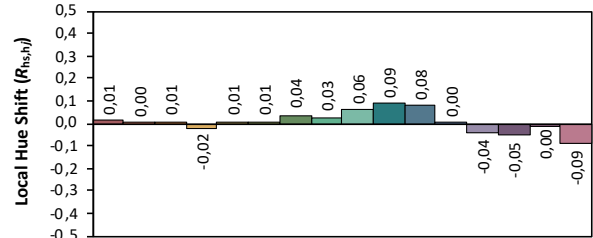
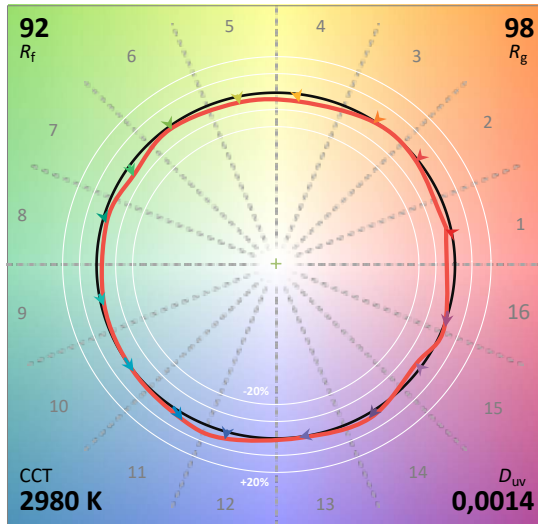
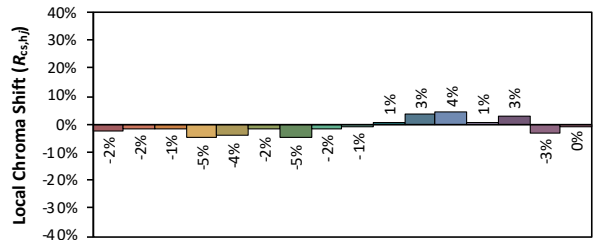
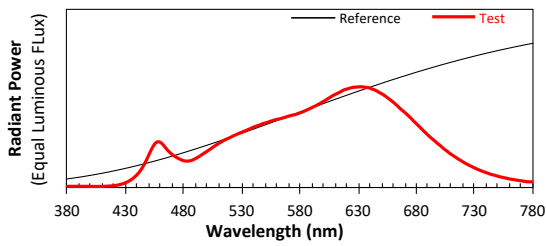

Colours are for visual orientation purposes only. Created with the IES TM-30-18 Calculator Version 2.00