

ZEP2 - 661SX2 NDW

660SX - LED 300 W



- **Type:** Profile spot
- **Source:** LED 300 W
- **Optics:** 11° to 26° zoom
- **Colour temperature:** Neutral Daylight White

Profile spot

Enhanced LED performance for the ZEP2 member!

Equipped with an enhanced white LED source providing a higher light quality and output, the ZEP 660 SX2 LED profile spot can be used as a direct complement or replacement for traditional 1k or 2k units but uses only 300W of long life LED power resulting in huge cost saving. Designed with Robert Juliat's trademark qualities of ergonomic perfection, optical and mechanical excellence, ZEP2 features a smooth flat beam, an excellent colour rendering index and suit every application from the smallest theatre to the largest spectacular.

Features

- **Multi-function double gate:** simultaneous use of gobos and iris. Sharp focus of both gobo and shutter
- **Shutter gate:** up to 8 shutters. Remove shutters for easy maintenance or tuck fully inside gate for secure transport
- **User-friendly shutter-lock system:** secures shutters' setting in any circumstances (locking efficient up to 4 shutters)
- **Universal gobo holder:** "A" size glass and metal gobo
- **90° rotating lens tube / gate / front accessories holder:** rotation of the projected image is always possible – no need to move the yoke
- **Internal glass filter holder:** long term use of durable coloured, dichroic or textured glass
- **Remote setup:** all parameters can be adjusted by RDM protocol
- **Adjustable response time:** choice of fast or slow dimming for tungsten-like simulation
- **DMX:** 8 or 16 bit dimming and strobe function
- **Local setup:** DMX address and mode, dimming curve and response time through 4-button display with automatic light switch-off
- **Control:** local, DMX, wireless DMX (option)
- **Easy focus reference:** graduated scale on side of the unit; fast and easy refocusing
- **Tilt reference on hanging yoke:** index for rapid re-positioning

Optical

- **Long life:** outstanding operational lifetime expectation, no need to replace lamps, low maintenance
- **SX optical system:** double condenser optics for exceptional optical quality
- **Coated double condenser optical system:** ensures optimal light transmission
- **Variable zoom optics:** sharp focus at every beam angle. Independent control of image size and focus. Focus handles on both sides
- **Electronic dimmer:** dimming without clipping or cut-out at low intensity levels; high quality smoothing
- **No colour shift:** colour temperature remains the same when dimming

Construction

- **Made in France :** fully manufactured in Robert Juliat premises retaining complete control over all aspects of quality
- **PSU:** built-in electronic flicker-free power supply for easy, plug-and-play installation
- **Power connectors:** compatible powerCON® TRUE1 IN and OUT connectors for daisy chaining
- **Silent-running cooling fans:** ideal for TV studios and opera houses
- **Electronic thermal management system:** ensures maximum performance of the system without any risk of overheating
- **Bodywork:** strong sheet metal construction for durability
- **Captive knobs and handles:** additional security when working at height or in transit
- **Spare parts and accessories:** interchangeable across the tungsten, discharge or LED ranges, reducing running costs
- **Easy access to all parts:** easy cleaning and maintenance

Picture:664SX

DSEN312_661SX2_NDW - 08/11/2024

Robert Juliat reserves the right to change or alter any of the items detailed on this page, to increase or improve manufacturing techniques without prior notice.

Robert Juliat S.A.S., 32 rue de Beaumont, 60530 Fresnoy-en-Thelle - France
Telephone : +33 (0)3 44 26 51 89 - info@robertjuliat.fr - www.robertjuliat.com



ROBERT JULIAT

Source (Light quality report(s) available at the end of the document)

- **Lamp type:** LED
- **Power:** 247 W

LED specifications	Power *	Lumen output*	Colour temperature*	Life*	CRI* (min)
SUHD60 V3 NDW (RJ / Osram)	247 W	24 150 lm	5000K	100 000 h	92

(*) manufacturer's data

Optics

Characteristics

- **Type:** Zoom
- **Range:** 11° to 26° (Field angle)
- **Focal length:** 173 - 415 mm

Gel filter

- **Shape:** Square
- **Standard size:** 180x180 mm (7.1x7.1 in)
- **Optional size:** 185x185 mm (7.3x7.3 in)

Gobo

- **Size:** A
- **Material:** Metal
Glass

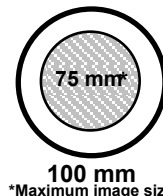

Photometrics (Photometrics report(s) available at the end of the document)

optics: 11°-26° / Standard

• Optics @ 11°

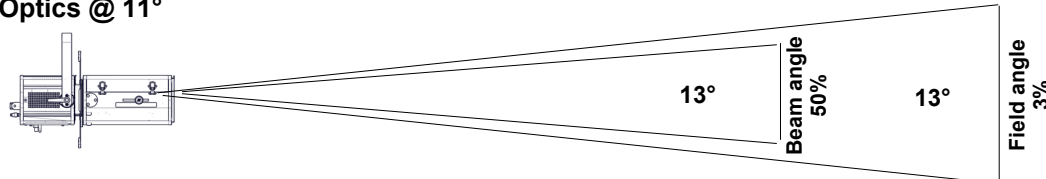

Beam intensity
207 800 cd

Field lumens
6 390 lm

Efficacy
25 lm/W

Distance	5 m	10 m	15 m	20 m	25 m	30 m
Diameter	1.1 m	2.3 m	3.4 m	4.6 m	5.7 m	6.8 m
Illumination	8 400 lux	2 100 lux	930 lux	520 lux	340 lux	240 lux
Distance	15 ft	35 ft	50 ft	65 ft	80 ft	100 ft
Diameter	3.4 ft	8 ft	11.4 ft	14.8 ft	18.2 ft	22.8 ft
Illumination	930 fc	170 fc	85 fc	50 fc	33 fc	21 fc

• Optics @ 26°

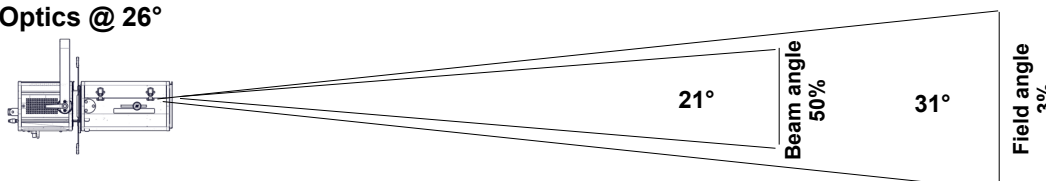

Beam intensity
100 900 cd

Field lumens
12 160 lm

Efficacy
43 lm/W

Distance	5 m	10 m	15 m	20 m	25 m	30 m
Diameter	2.8 m	5.5 m	8.3 m	11.1 m	13.9 m	16.6 m
Illumination	4 050 lux	1 050 lux	450 lux	260 lux	170 lux	120 lux
Distance	15 ft	35 ft	50 ft	65 ft	80 ft	100 ft
Diameter	8.3 ft	19.4 ft	27.7 ft	36.1 ft	44.4 ft	55.5 ft
Illumination	450 fc	85 fc	41 fc	24 fc	16 fc	11 fc

Remote control

- **Data protocol:** USITT DMX512-A
RDM

- **Data IN connector:** 5 pins XLR male
- **Data OUT connector:** 5 pins XLR female

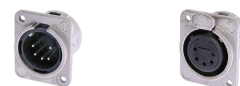

• DMX chart:

Mode 1 (1 channels)

Dimmer

Mode 2 (4 channels)

Dimmer
Dimmer fine
-
Strobe

Mode 3 (5 channels)

Dimmer
Dimmer fine
-
Strobe
Dimmer master

Dimensions and weight

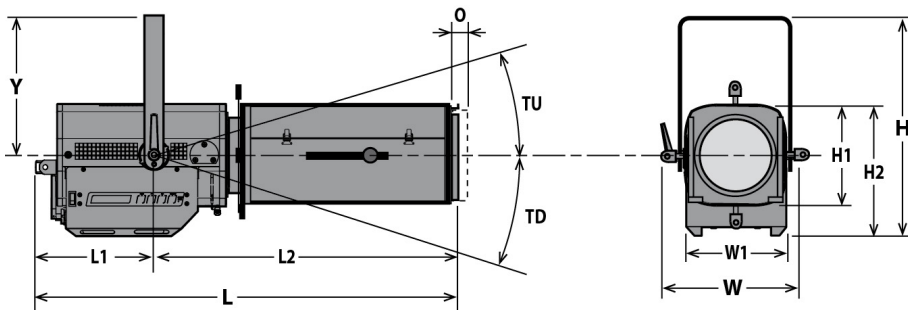

Weight: 18 kg (39.6 lbs)

Height	Length	Width	Yoke	Tilt	Option
H= 447 mm (17.6 in)	L= 902 mm (35.5 in)	W= 330 mm (13 in)	Y= 280 mm (11 in)	TU= 60°	O= 25 mm (1 in)
H1= 208 mm (8.2 in)	L1= 241 mm (9.5 in)	W1= 208 mm (8.2 in)		TD= 90°	
H2= 268 mm (10.6 in)	L2= 661 mm (26 in)				

Shipping

- **Weight :** 20.4 kg (44.9 lbs)
- **Volume :** .16 m³ (5.65 ft³)

Installation

- **Minimum distance to illuminated surface:** 0.7 m (2.3 ft)
- **Operating position:**

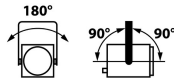

Construction

- **Housing:** Steel sheet - Aluminium
- **Colour:** Black
- **Cooling:** Low noise variable fan
- **Maximum ambient temperature (Ta):** 40°C (104°F)
- **Maximum case temperature (Tc):** 70°C (158°F)
- **Total heat dissipation:** 976 BTU/h
- **Ingress Protection (IP) rating:** IP20

Electrical compatibility

- 220/230 V - 50 Hz
- 245 V - 50 Hz
- 110/120 V - 60 Hz
- 208 V - 60 Hz
- 220/230 V - 60 Hz
- 100 V - 50 Hz
- 100 V - 60 Hz
- Selector: automatic detection

Power input



- **Type:** removable power cord with compatible powerCON® TRUE1 connector (included)
- **Cable:** H07RNF 3G1.5
- **Length:** 3 m (9.8 ft)
- **Power connector:** CEE 7/7 (2P+E NF/Schuko)

Power consumption

Voltage	Frequency	Current	Power	Power factor
230 V	50 Hz	1.3 A	286 W	0.97
120 V	60 Hz	2.5 A	291 W	0.99
100 V	60 Hz	3 A	295 W	0.99

Power Supply Unit

- **PSU:** Internal - Electronic PSU - Flicker free with PFC
- **Control:** Local / DMX
- **Protection:** Mains: 4A 1P1D breaker - UL /
- **Power thru:** compatible powerCON® TRUE1 - Maximum of 10 units (230 V) / 5 units (120 V)

Warranty

- **Fixture: 3 years - Source: 5 years**
See General Sales Condition on website

Approvals





Acoustics

- **Noise level:** < 24,9 dB(A)













Model



661SX2 NDW	LED 300 W Profile spot - 661SX2 NDW ZEP2 - Neutral Daylight White - 11/26°
-------------------	--

Options

CAV600	Double slot front cassette for 180x180mm accessories	
CAV600E	Double slot front cassette for 185x185mm accessories	
PCP1716A	16A blue 2P+E 6h IEC60309 power connector	

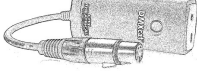
Accessories

D8	Shutter for SX series 4 included	
PF500M2	180x180mm metal filter holder 1 included	
SGUX	Universal "A" size gobo-holder (metal, glass, frosted glass) 1 included	
IWSX755	Drop-in iris (monoplane) with holder - Weight: 0.26 Kg	
D8	Shutter for SX series	
PF600M2	185x185mm metal filter holder	
G500	180x180mm safety grid	
CAV600A	Double slot front cassette for 180x180mm accessories - Weight: 0.43 Kg	
CAV600AE	Double slot front cassette for 185x185mm accessories - Weight: 0.45 Kg	
VD120	120x120mm frosted glass	
FCD600	Angled yoke	
TH600	180x180mm "Top hat" (without safety cable) - ø150mm / 150mm long	
DMXcat	Bluetooth DMX/RDM Multifunction test tool - City Theatrical DMXcat®	

876	Hook clamp 40x10mm with 28mm M10 screw for Ø35 to 50mm pipes - SWL: 50Kg - Weight: 1.25 Kg	
880	Hook clamp 40x10mm with 28mm M10 screw for Ø50 to 63mm pipes - SWL: 50Kg - Weight: 1.36 Kg	
CS2	Safety cable Ø3 mm L= 600mm - SWL: 75 Kg	

• Optics @ 11°

Field lumens	Beam lumens	Efficacy	Beam intensity	CCT	Delta uv
6 390 Lm		25 Lm/W	207 800 Cd	4 950 K	

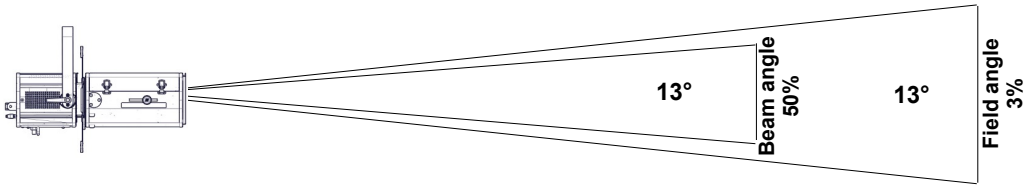

Distance	5 m	10 m	15 m	20 m	25 m	30 m
Field diameter	1,1 m	2,3 m	3,4 m	4,6 m	5,7 m	6,8 m
Illumination	8 400 lux	2 100 lux	930 lux	520 lux	340 lux	240 lux
Distance	15 ft	35 ft	50 ft	65 ft	80 ft	100 ft
Field diameter	3,4 ft	8 ft	11,4 ft	14,8 ft	18,2 ft	22,8 ft
Illumination	930 fc	170 fc	85 fc	50 fc	33 fc	21 fc

• Optics @ °

Field lumens	Beam lumens	Efficacy	Beam intensity	CCT	Delta uv
10 060 Lm		35 Lm/W	209 100 Cd	5 040 K	

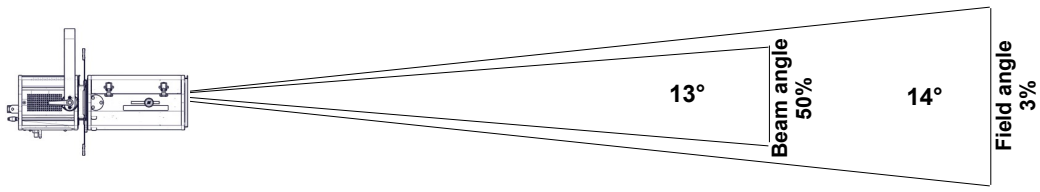

Distance	5 m	10 m	15 m	20 m	25 m	30 m
Field diameter	1,2 m	2,5 m	3,7 m	4,9 m	6,1 m	7,4 m
Illumination	8 400 lux	2 100 lux	930 lux	530 lux	340 lux	240 lux
Distance	15 ft	35 ft	50 ft	65 ft	80 ft	100 ft
Field diameter	3,7 ft	8,6 ft	12,3 ft	16 ft	19,6 ft	24,6 ft
Illumination	930 fc	180 fc	85 fc	50 fc	33 fc	21 fc

• Optics @ 26°

Field lumens	Beam lumens	Efficacy	Beam intensity	CCT	Delta uv
12 160 Lm		43 Lm/W	100 900 Cd	5 090 K	

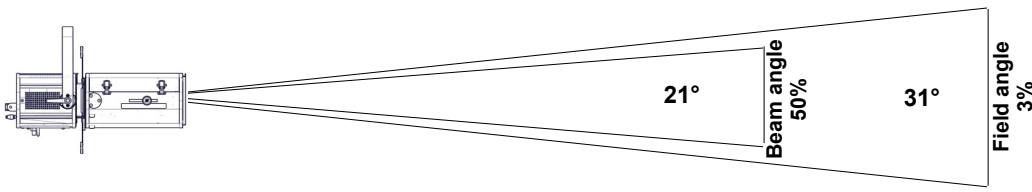

Distance	5 m	10 m	15 m	20 m	25 m	30 m
Field diameter	2,8 m	5,5 m	8,3 m	11,1 m	13,9 m	16,6 m
Illumination	4 050 lux	1 050 lux	450 lux	260 lux	170 lux	120 lux
Distance	15 ft	35 ft	50 ft	65 ft	80 ft	100 ft
Field diameter	8,3 ft	19,4 ft	27,7 ft	36,1 ft	44,4 ft	55,5 ft
Illumination	450 fc	85 fc	41 fc	24 fc	16 fc	11 fc

Light quality report

CCT	DeltaUV	CRI Ra	CRI R9	CQS Qa	TM30-18 Rf	TM30-18 Rg	TLCI
5 350K	-0.0001	93	70	90	91	99	94

CRI - CIE Colour Rendering Index

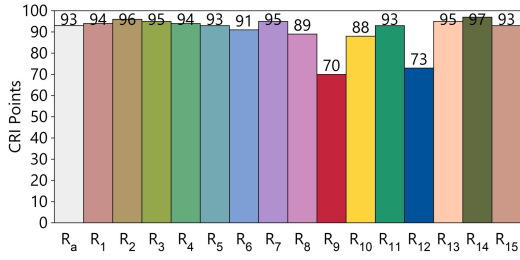

TLCI - Television Lighting Consistency Index

Test : CCT = D5352 (-0.6)
 TLCI-2012 : 94 (D5352)

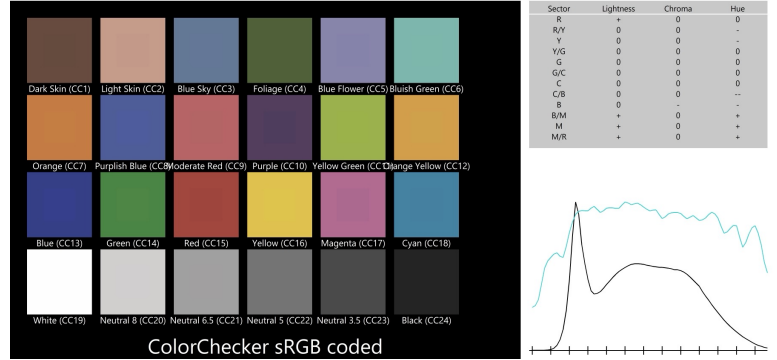

CQS - NIST Colour Quality Scale

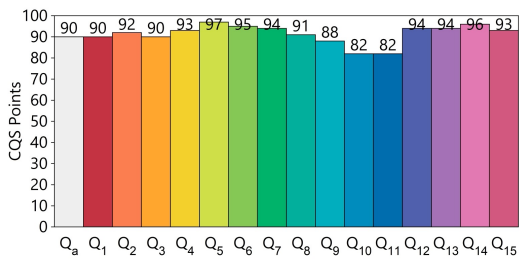

ANSI/IES TM-30-18 Colour Rendition Report

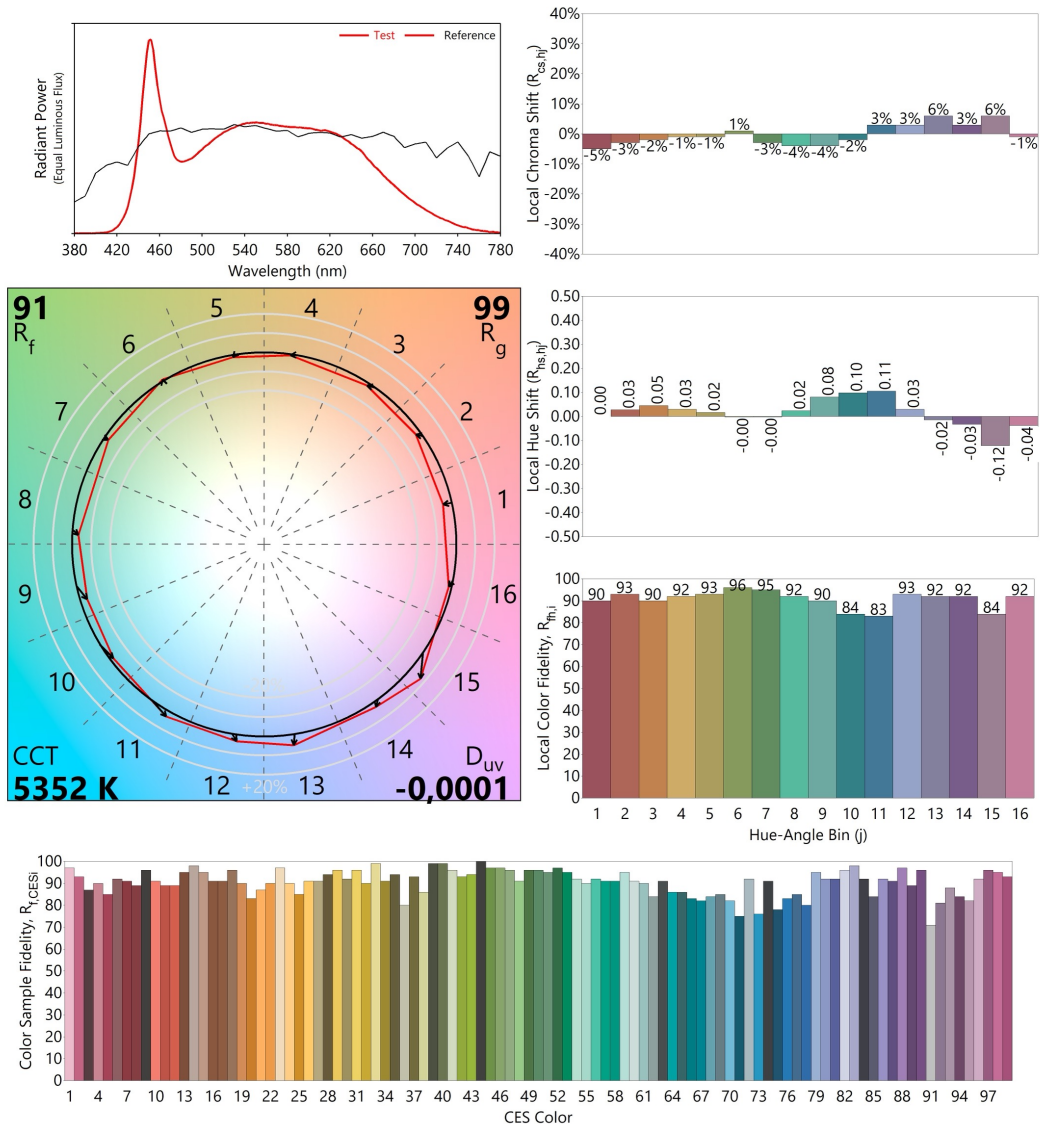

Colours are for visual orientation purposes only. Created with the IES TM-30-18 Calculator Version 2.00