

713SX2

700SX2 - 2000/2500 W TUNGSTEN



- **Type:** Profile spot
- **Source:** 2000/2500 W Tungsten
- **Optics:** 29° to 50° zoom

Profile spot

The ideal zoom profile for all short throw applications

Combining power with a smooth flat beam, the 713 SX2 is the perfect profile for all short throw applications in medium to large theatres and opera houses. Its secure G22 lamp socket ensures reliability, longer lamp life, and 2000 W or 2500 W lamp options.

Features

- **Multi-function double gate:** simultaneous use of gobos and iris. Sharp focus of both gobo and shutter
- **Shutter gate:** up to 8 shutters. Remove shutters for easy maintenance or tuck fully inside gate for secure transport
- **User-friendly shutter-lock system:** secures shutters' setting in any circumstances (locking efficient up to 4 shutters)
- **Universal gobo holder:** "A" size glass and metal gobo
- **Lens tube lock feature:** secures rotating lens tube against unwanted movement
- **90° rotating lens tube / gate / front accessories holder:** rotation of the projected image is always possible while the lamp remains vertical – no need to move the yoke
- **Internal glass filter holder:** long term use of durable coloured, dichroic or textured glass
- **Easy focus reference:** graduated scale on side of the unit; fast and easy refocusing
- **Tilt reference on hanging yoke:** index for rapid re-positioning

Optical

- **Factory set optical train:** no re-alignment even after lamp change
- **SX optical system:** double condenser optics for exceptional optical quality
- **Variable zoom optics:** sharp focus at every beam angle. Independent control of image size and focus. Focus handles on both sides

Construction

- **Made in France :** fully manufactured in Robert Juliat premises retaining complete control over all aspects of quality
- **G22 socket locking system exclusive to Robert Juliat:** holds the lamp securely in place to ensure there is no arcing, even when the fixture is pointing vertically downward
- **Silent-running cooling fans:** ideal for TV studios and opera houses
- **Bodywork:** strong sheet metal construction for durability
- **Moving parts:** smooth at all times, even when hot
- **Captive knobs and handles:** additional security when working at height or in transit
- **Easy access to all parts:** easy cleaning, re-lamping and maintenance
- **Removable assemblies:** fast-plug cable connectors and complete component assemblies (mirror, condenser set and lamp house assembly) save maintenance and cleaning time
- **Spare parts and accessories:** interchangeable across the tungsten, discharge or LED ranges, reducing running costs

Picture:713SX2

DSEN071_713SX2 - 08/11/2024

Robert Juliat reserves the right to change or alter any of the items detailed on this page, to increase or improve manufacturing techniques without prior notice.

Robert Juliat S.A.S., 32 rue de Beaumont, 60530 Fresnoy-en-Thelle - France
Telephone : +33 (0)3 44 26 51 89 - info@robertjuliat.fr - www.robertjuliat.com



ROBERT JULIAT

Source



- **Lamp type:** Tungsten
- **Socket:** G22

Admissible lamps	Power *	Lumen output*	Colour temperature*	Life*
LIF: CP92	2 000 W	52 000 lm	3200K	400 h
LIF: CP91	2 500 W	65 000 lm	3200K	400 h

(*) manufacturer's data

Optics

Characteristics

- **Type:** Zoom
- **Range:** 29° to 50° (Field angle)
- **Focal length:** 86 - 155 mm

Gel filter

- **Shape:** Square
- **Standard size:** 215x215 mm (8.5x8.5 in)

Gobo

- **Size:** A
- **Material:** Metal
Glass



Photometrics

optics: 29°-50° / Standard / LIF: CP91 2500W

• Optics @ 29°

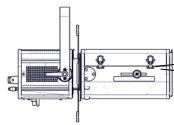

29°

Field angle
3%

Beam intensity
160 000 cd

Distance	5 m	10 m	15 m	20 m	25 m	30 m
Diameter	2.6 m	5.2 m	7.8 m	10.3 m	12.9 m	15.5 m
Illumination	6 500 lux	1 650 lux	720 lux	410 lux	260 lux	180 lux
Distance	15 ft	35 ft	50 ft	65 ft	80 ft	100 ft
Diameter	7.8 ft	18.1 ft	25.9 ft	33.6 ft	41.4 ft	51.7 ft
Illumination	720 fc	140 fc	65 fc	38 fc	26 fc	17 fc

• Optics @ 50°

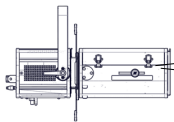

50°

Field angle
3%

Beam intensity
56 000 cd

Distance	5 m	10 m	15 m	20 m	25 m	30 m
Diameter	4.7 m	9.3 m	14 m	18.7 m	23.3 m	28 m
Illumination	2 250 lux	570 lux	250 lux	150 lux	90 lux	65 lux
Distance	15 ft	35 ft	50 ft	65 ft	80 ft	100 ft
Diameter	14 ft	32.6 ft	46.6 ft	60.6 ft	74.6 ft	93.3 ft
Illumination	250 fc	46 fc	23 fc	14 fc	9 fc	6 fc

Dimensions and weight

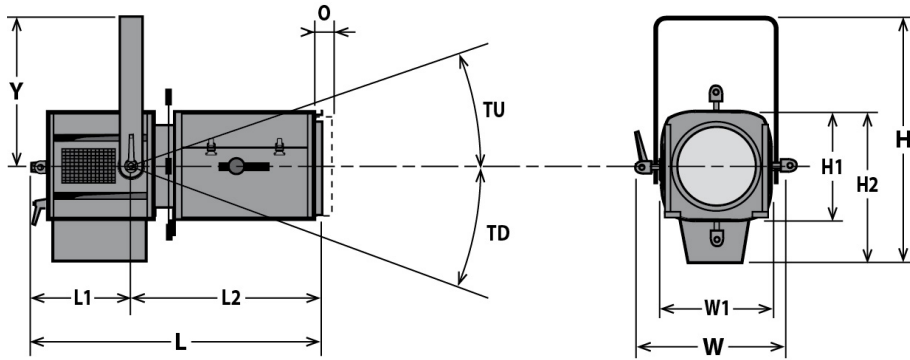

Weight: 18 kg (39.6 lbs)

Height	Length	Width	Yoke	Tilt	Option
H= 525 mm (20.7 in)	L= 655 mm (25.8 in)	W= 380 mm (15 in)	Y= 325 mm (12.8 in)	TU= TBD°	O= 25 mm (1 in)
H1= 250 mm (9.8 in)	L1= 265 mm (10.4 in)	W1= 250 mm (9.8 in)		TD= TBD°	
H2= 330 mm (13 in)	L2= 390 mm (15.4 in)				

Shipping

- **Weight :** 22 kg (48.4 lbs)
- **Volume :** .13 m³ (4.59 ft³)

Installation

- **Minimum distance to illuminated surface:** 1.5 m (4.9 ft)
- **Operating position:**



Construction

- **Housing:** Steel sheet - Aluminium
- **Colour:** Black
- **Cooling:** Low noise fan
- **Maximum ambient temperature (Ta):** 40°C (104°F)
- **Maximum case temperature (Tc):** 270°C (518°F)
- **Total heat dissipation:** 6 826 BTU/h
- **Ingress Protection (IP) rating:** IP20

Electrical compatibility

- 230/240 V - 50 Hz
- ~~115/120 V - 60 Hz~~

Power input



- **Type:** attached power cord
- **Cable:** H07RNF 3G1.5
- **Length:** 3 m (9.8 ft)
- **Power connector:** CEE 7/7 (2P+E NF/Schuko)

Power consumption

Voltage	Frequency	Current	Power
230 V	50 Hz	9 A	2000 W
230 V	50 Hz	11 A	2500 W

Warranty

- **Fixture: 2 years**
- See General Sales Condition on website



Approvals















Model



713SX2	2000/2500 W Tungsten Profile spot - G22 socket - 713SX2 - 29/50°
---------------	--

Options

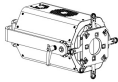
CAV700	Double slot front cassette for 215x215mm accessories	
CAV700J	Double slot front cassette for 245x245mm accessories	
PCP1716A	16A blue 2P+E 6h IEC60309 power connector	

Accessories

D8	Shutter for SX series 4 included	
PF1000M2	215x215mm metal filter holder 1 included	
SGUX	Universal "A" size gobo-holder (metal, glass, frosted glass) 1 included	
CP91	CP91 - G22 2500W 230V 400h 3200K lamp	
CP92	CP92 - G22 2000W 230V 400h 3200K lamp	
IWSX755	Drop-in iris (monoplane) with holder - Weight: 0.26 Kg	
G1000	215x215mm safety grid	
CAV700A	Double slot front cassette for 215x215mm accessories - Weight: 0.52 Kg	
CAV700AJ	Double slot front cassette for 245x245mm accessories - Weight: 0.95 Kg	
RPF713	Front extension cassette for 215x215mm accessories without fan - Weight: 1.5 Kg	
RV934	Front extension cassette for 215x215mm accessories with fan - Weight: 2 Kg	
LH/670SXVW	500W VW LED profile lamp house Bizet for 6X1/6X3/6X4/713/714SX optics with yoke	
VD120	120x120mm frosted glass	

FCD700	Angled yoke - Weight: 1.62 Kg	
876	Hook clamp 40x10mm with 28mm M10 screw for Ø35 to 50mm pipes - SWL: 50Kg - Weight: 1.25 Kg	
880	Hook clamp 40x10mm with 28mm M10 screw for Ø50 to 63mm pipes - SWL: 50Kg - Weight: 1.36 Kg	
CS2	Safety cable Ø3 mm L= 600mm - SWL: 75 Kg	