

614SX

6005X - 1000/1200 W TUNGSTEN



- **Type:** Profile spot
- **Source:** 1000/1200 W Tungsten
- **Optics:** 16° to 35° zoom

Profile spot

The classic 1/1.2K theatre zoom profile

The most versatile of the Juliat profiles, the medium throw 614 SX is equally happy on-stage, overhead, on side booms, prosceniums or front of house. Its advanced functions and optical quality make this fixture indispensable in opera houses, theatres and studios.

Interchangeable lamp bases can be swapped with the Quincy range to give a choice of tungsten or discharge options.

Features

- **Multi-function double gate:** simultaneous use of gobos and iris. Sharp focus of both gobo and shutter
- **Shutter gate:** up to 8 shutters. Remove shutters for easy maintenance or tuck fully inside gate for secure transport
- **User-friendly shutter-lock system:** secures shutters' setting in any circumstances (locking efficient up to 4 shutters)
- **Universal gobo holder:** "A" size glass and metal gobo
- **Lens tube lock feature:** secures rotating lens tube against unwanted movement
- **90° rotating lens tube / gate / front accessories holder:** rotation of the projected image is always possible while the lamp remains vertical – no need to move the yoke
- **Internal glass filter holder:** long term use of durable coloured, dichroic or textured glass
- **Easy focus reference:** graduated scale on side of the unit; fast and easy refocusing
- **Tilt reference on hanging yoke:** index for rapid re-positioning

Optical

- **Multiposition socket:** accepts 1000 W and 1200 W lamps
- **Factory set optical train:** no re-alignment even after lamp change
- **SX optical system:** double condenser optics for exceptional optical quality
- **Variable zoom optics:** sharp focus at every beam angle. Independent control of image size and focus. Focus handles on both sides

Construction

- **Made in France :** fully manufactured in Robert Juliat premises retaining complete control over all aspects of quality
- **Interchangeable lamp base:** with Sully (115W LED) series
- **Air vents:** efficient cooling with no light spill
- **Bodywork:** strong sheet metal construction for durability
- **Moving parts:** smooth at all times, even when hot
- **Captive knobs and handles:** additional security when working at height or in transit
- **Easy access to all parts:** easy cleaning, re-lamping and maintenance
- **Spare parts and accessories:** interchangeable across the tungsten, discharge or LED ranges, reducing running costs

Picture:614SX

DSEN049_614SX - 24/02/2021

Robert Juliat reserves the right to change or alter any of the items detailed on this page, to increase or improve manufacturing techniques without prior notice.

Robert Juliat S.A.S., 32 rue de Beaumont, 60530 Fresnoy-en-Thelle - France
Telephone : +33 (0)3 44 26 51 89 - fax : +33 (0)3 44 26 90 79 - info@robertjuliat.fr
www.robertjuliat.com



ROBERT JULIAT

Source

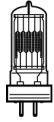

- **Lamp type:** Tungsten
- **Socket:** Gx9.5

Admissible lamps	Power *	Lumen output*	Colour temperature*	Life*
LIF: T19 (T11) - ANSI: FWP/FWR	1 000 W	21 000 lm	3050K	750 h
LIF: CP70 - ANSI: FVA/FVB	1 000 W	26 000 lm	3200K	200 h
LIF: T29 - ANSI: FWS/FWT	1 200 W	29 000 lm	3050K	400 h
LIF: CP90	1 200 W	30 000 lm	3200K	200 h

(*) manufacturer's data

Optics

Characteristics

- **Type:** Zoom
- **Beam range:** 16° to 35°
- **Focal length:** 127 - 285 mm

Gel filter

- **Shape:** Square
- **Standard size:** 180x180 mm (7.1x7.1 in)
- **Optional size:** 185x185mm (7.3x7.3")

Gobo

- **Size:** A
- **Material:** Metal
Glass

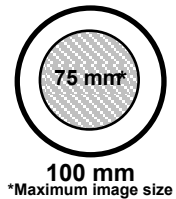

Photometrics

with LIF: CP70 - ANSI: FVA/FVB source

• Optics @ 16°

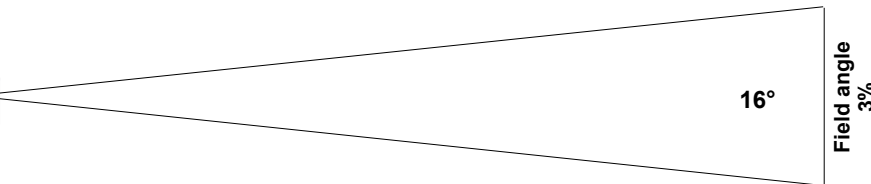
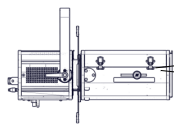

Beam intensity
190 000 cd

Distance	5 m	10 m	15 m	20 m	25 m	30 m
Diameter	1.4 m	2.8 m	4.2 m	5.6 m	7 m	8.4 m
Illumination	7 700 lux	1 950 lux	850 lux	480 lux	310 lux	220 lux
Distance	15 ft	35 ft	50 ft	65 ft	80 ft	100 ft
Diameter	4.2 ft	9.8 ft	14.1 ft	18.3 ft	22.5 ft	28.1 ft
Illumination	850 fc	160 fc	80 fc	45 fc	30 fc	20 fc

• Optics @ 35°

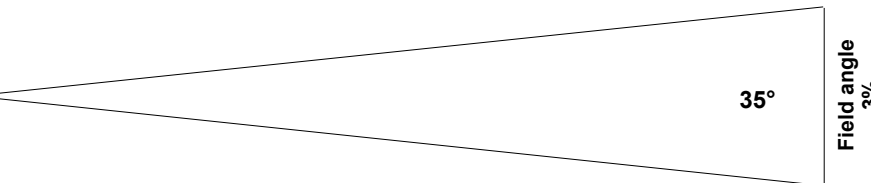
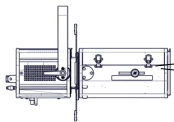

Beam intensity
51 000 cd

Distance	5 m	10 m	15 m	20 m	25 m	30 m
Diameter	3.2 m	6.3 m	9.5 m	12.6 m	15.8 m	18.9 m
Illumination	2 050 lux	520 lux	230 lux	130 lux	85 lux	60 lux
Distance	15 ft	35 ft	50 ft	65 ft	80 ft	100 ft
Diameter	9.5 ft	22.1 ft	31.5 ft	41 ft	50.4 ft	63.1 ft
Illumination	230 fc	42 fc	21 fc	13 fc	8 fc	6 fc

Dimensions and weight

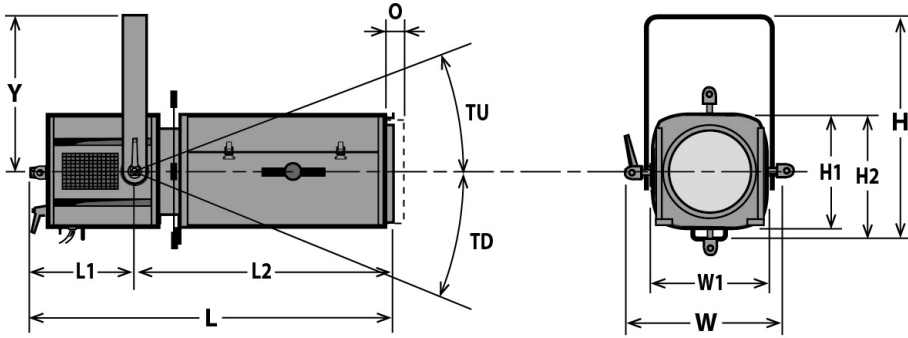

Weight: 13 kg (28.6 lbs)

Height	Length	Width	Yoke	Tilt	Option
H= 415 mm (16.3 in)	L= 695 mm (27.4 in)	W= 330 mm (13 in)	Y= 280 mm (11 in)	TU= TBD°	O= 25 mm (1 in)
H1= 208 mm (8.2 in)	L1= 250 mm (9.8 in)	W1= 208 mm (8.2 in)		TD= TBD°	
H2= 240 mm (9.4 in)	L2= 445 mm (17.5 in)				

Shipping

- **Weight :** 15 kg (33 lbs)
- **Volume :** .09 m³ (3.18 ft³)

Installation

- **Minimum distance to illuminated surface:** 2.0 m (6.6 ft)
- **Operating position:**



Construction

- **Housing:** Steel sheet - Aluminium
- **Colour:** Black
- **Cooling:** Convection cooling
- **Maximum ambient temperature (Ta):** 40°C (104°F)
- **Maximum case temperature (Tc):** 260°C (500°F)
- **Total heat dissipation:** 3 413 BTU/h
- **Protection rating:** 20

Electrical compatibility

- 230/240 V - 50 Hz
- ~~115/120 V - 60 Hz~~

Warranty

- **Fixture: 2 years**
See General Sales Condition on website

Approvals



Power input



- **Type:** attached power cord
- **Cable:** H07RNF 3G1.5
- **Length:** 3 m (9.8 ft)
- **Power connector:** CEE 7/7 (2P+E NF/Schuko)





Power consumption

Voltage	Frequency	Current	Power
230 V	50 Hz	5 A	1000 W
230 V	50 Hz	6 A	1200 W













Model











614SX	1000/1200 W Tungsten Profile spot - Gx9.5 socket - 614SX - 16/35°
--------------	---

Options

CAV600	Double slot front cassette for 180x180mm accessories	
CAV600E	Double slot front cassette for 185x185mm accessories	
PCP1716A	16A blue 2P+E 6h IEC60309 power connector	
FCD600PV	Angled yoke	

Accessories

D8	Shutter for SX series 4 included	
PF500M2	180x180mm metal filter holder 1 included	
SGUX	Universal "A" size gobo-holder (metal, glass, frosted glass) 1 included	
CP70	CP70 - Gx9.5 1000W 230V 200h 3200K lamp	
T19 (T11)	T19 (T11) - Gx9.5 1000W 230V 750h 3050K lamp	
CP90	CP90 - Gx9.5 1200W 230V 200h 3200K lamp	
IWSX755	Drop-in iris (monoplane) with holder - Poids: 0.26 Kg	
PF600M2	185x185mm metal filter holder	
G500	180x180mm safety grid	
CAV600A	Double slot front cassette for 180x180mm accessories - Poids: 0.43 Kg	
CAV600AE	Double slot front cassette for 185x185mm accessories - Poids: 0.45 Kg	
RPF613	180x180mm front extension cassette for 215x215mm accessories without fan (recommended for dark colours on 613SX/663SX) - Poids: 1.5 Kg	

RPF613E	180x180mm front extension cassette for 245x245mm accessories without fan (recommended for dark colours on 613SX/663SX)	
APH 68LED	Double-condenser set for Led profile - Poids: 0.58 Kg	
T/600VSX	Lamp compartment for 1000/1200W tungsten G22 lamps with fan - 3 meter power cable with CEE 7/7 (2P+T NF/SCHUKO) connector - Poids: 2.03 Kg	
T/650SXCW	SULLY 115W LED compartment - Cool White - 3 meter power cable with CEE 7/7 (2P+T NF/SCHUKO) connector - Poids: 2.27 Kg	
T/650SXWW	SULLY 115W LED compartment - Warm White - 3 meter power cable with CEE 7/7 (2P+T NF/SCHUKO) connector - Poids: 2.27 Kg	
VD120	120x120mm frosted glass	
FCD600	Angled yoke	
TH600	180x180mm "Top hat" (without safety cable)	
876	Hook clamp 40x10mm with 28mm M10 screw for Ø35 to 50mm pipes - SWL: 50Kg - Poids: 1.25 Kg	
880	Hook clamp 40x10mm with 28mm M10 screw for Ø50 to 63mm pipes - SWL: 50Kg - Poids: 1.36 Kg	
CS2	Safety cable Ø3 mm L= 600mm - SWL: 75 Kg	