

BERLIOZ - 1179C

LED COMPACT - LED 420 W



- **Type:** Followspot
- **Source:** LED 420 W
- **Optics:** 7° to 14.5° zoom
- **Colour temperature:** Cool White
- **Standard:** 110 V North american

Followspot

High output comparable to 1200W discharge followspot

Tristan's little brother and worthy heir of Oz, the 1179 model is a powerful 420W LED followspot that seamlessly merges the compact design of Tristan with the capacity to deliver the output performance of Oz. Engineered with the same trusted body and form factor as Tristan, it combines long throw, precision, and beam quality worthy of the Oz model. Featuring a manual iris and a 7-14.5° zoom, the 1179 model is designed for venues that demand high performance in a compact footprint.

Features

- **Fully closing iris:** ergonomic control with adjustable handle
- **Universal adjustable gobo holder:** "A" size glass and metal gobos
- **Ergonomic dimmer control:** one-handed dim, pan and tilt
- **Frost filter:** on flip lever for quick soft-edge beam effect
- **Horizontal chopper (optional):** for masking control in TV studios and wide stages
- **Internal glass filter holder:** long term use of durable coloured, dichroic or textured glass
- **Individually removable colour frame:** gels replaced easily while colour cassette remains in place
- **Colour changer:** 6-way, self-cancelling boomerang colour-changer
- **USB connector:** for connection of additional accessories
- **Adjustable response time:** choice of fast or slow dimming for tungsten-like simulation - adjustment by DMX protocol
- **Ethernet-DMX node:** data IN through RJ45 connector; data OUT through DMX for daisy chaining
- **Universal data control:** compatible with DMX, RDM, Art-Net, sACN protocols
- **Remote setup:** all parameters can be adjusted by RDM protocol or by web interface
- **PWM adjustment:** choice of different PWM dimming frequencies - continuous mode available
- **Advanced Ethernet node functionalities:** compatible with RDM, LLRP, Zeroconf protocols
- **Local setup:** DMX address and mode, dimming curve and response time through 4-button display with automatic light switch-off
- **Dimming parameters:** choice of square or linear dimming curves
- **DMX:** 8 or 16 bit dimming, response time and strobe function
- **Easy focus reference:** graduated scale on side of the unit; fast and easy refocusing
- **Stand:** perfectly weighted for maximum stability with smooth rotation for optimum performance. Easy set up; triple safety system for extra security

Optical

- **Long life:** outstanding operational lifetime expectation, no need to replace lamps, low maintenance
- **High output:** comparable to 1200W discharge followspots
- **Native high CRI LED source:** CRI > 90 - perfect for performer illumination - no need for correction filter
- **Gobo :** excellent gobo projection
- **Optical quality:** smooth flat beam, no hot spot
- **Variable zoom optics:** sharp focus at every beam angle. Independent control of image size and focus.
- **Electronic dimmer:** dimming without clipping or cut-out at low intensity levels; high quality smoothing
- **No colour shift:** colour temperature remains the same when dimming

Construction

- **Made in France :** fully manufactured in Robert Juliat premises retaining complete control over all aspects of quality
- **PSU:** built-in electronic flicker-free power supply for easy, plug-and-play installation
- **Power connectors:** compatible powerCON® TRUE1 IN and OUT connectors for daisy chaining
- **Silent-running cooling fans:** ideal for TV studios and opera houses
- **Electronic thermal management system:** ensures maximum performance of the system without any risk of overheating
- **3 cooling modes available:** includes a silent mode for perfect integration in concert halls
- **Bodywork:** strong sheet metal construction for durability
- **Ergonomic wrap-around handle:** comfort, safety and practicality from all operating positions
- **Moving parts:** smooth at all times, even when hot
- **Captive knobs and handles:** additional security when working at height or in transit
- **Fine balance:** precision positioning and smooth operation even with the smallest movements
- **Easy access to all parts:** easy cleaning and maintenance

Picture:1179

DSEN447_1179C - 08/04/2026

Robert Juliat reserves the right to change or alter any of the items detailed on this page, to increase or improve manufacturing techniques without prior notice.

Robert Juliat S.A.S., 32 rue de Beaumont, 60530 Fresnoy-en-Thelle - France
Telephone : +33 (0)3 44 26 51 89 - info@robertjuliat.fr - www.robertjuliat.com



ROBERT JULIAT

Source

- Lamp type: LED
- Power: 420 W

LED specifications	Power *	Lumen output*	Colour temperature*	Life*
TCW03	420 W	41 400 lm	6500K	30 000 h

(*) manufacturer's data

Optics

Characteristics

- Type: Zoom
- Range: 7° to 14.5° (Field angle)
- Focal length: - mm

Gel filter

- Shape: Circle
- Standard size: 210 mm (8.3 in)

Gobo

- Size: A
- Material: Metal
Glass



Photometrics

optics: 7°-14,5° / Standard

• Optics @ 7°

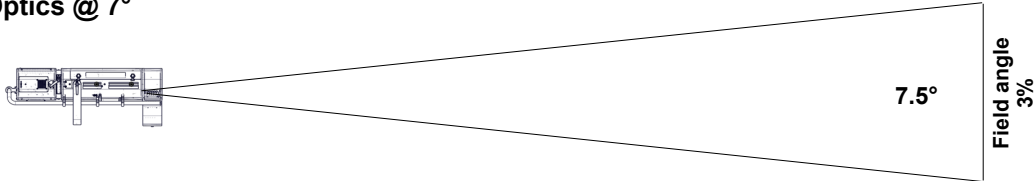

Beam intensity
1 263 900 cd

Field lumens
12 990 lm

Efficacy
28 lm/W

CCT
6 170 K

CRI
93

Distance	10 m	15 m	20 m	25 m	30 m	35 m
Diameter	1.3 m	2 m	2.6 m	3.3 m	3.9 m	4.6 m
Illumination	13 000 lux	5 700 lux	3 200 lux	2 050 lux	1 450 lux	1 050 lux
Distance	35 ft	50 ft	65 ft	80 ft	100 ft	115 ft
Diameter	4.6 ft	6.6 ft	8.5 ft	10.5 ft	13.1 ft	15.1 ft
Illumination	1 050 fc	510 fc	300 fc	200 fc	130 fc	100 fc

• Optics @ 14.5°

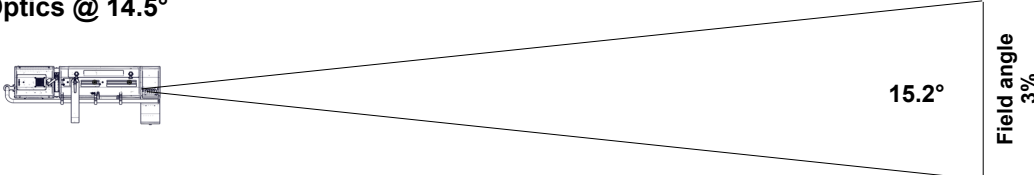

Beam intensity
515 600 cd

Field lumens
18 600 lm

Efficacy
40 lm/W

CCT
6 140 K

CRI
93

Distance	10 m	15 m	20 m	25 m	30 m	35 m
Diameter	2.7 m	4 m	5.3 m	6.7 m	8 m	9.3 m
Illumination	5 200 lux	2 300 lux	1 300 lux	830 lux	580 lux	430 lux
Distance	35 ft	50 ft	65 ft	80 ft	100 ft	115 ft
Diameter	9.3 ft	13.3 ft	17.3 ft	21.3 ft	26.7 ft	30.7 ft
Illumination	430 fc	210 fc	130 fc	85 fc	55 fc	39 fc

Remote control

- Data protocol: USITT DMX512-A
RDM / Art-Net / sACN

- Data IN connector: 5 pins XLR male + etherCON RJ45
- Data OUT connector 5 pins XLR female



• DMX chart:

Mode 1 (1 channels)

Dimmer

Mode 2 (6 channels)

Dimmer
Dimmer fine
Strobe duration
Strobe speed
Response time
Control mode

Mode 3 (8 channels)

Dimmer
Dimmer fine
Master dimmer
Master dimmer fine
Strobe duration
Strobe speed
Response time
Control mode

Dimensions and weight

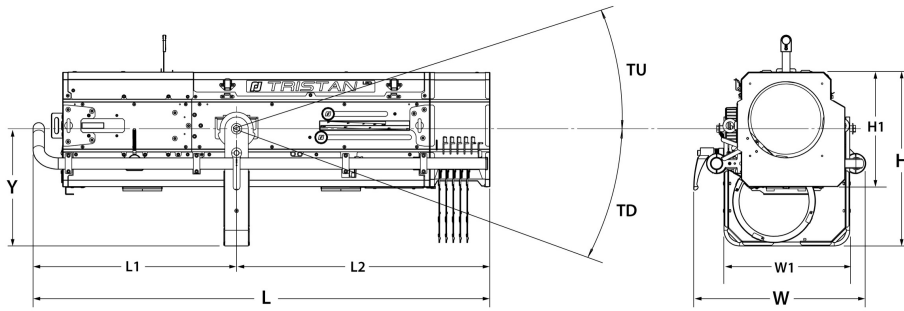

Weight: 35.8 kg (78.8 lbs)

Height	Length	Width	Yoke	Tilt
H= 445 mm (17.5 in)	L= 1174 mm (46.2 in)	W= 435 mm (17.1 in)	Y= 304 mm (12 in)	TU= 50°
H1= 294 mm (11.6 in)	L1= 523 mm (20.6 in)	W1= 323 mm (12.7 in)		TD= 50°
	L2= 651 mm (25.6 in)	W2= 250 mm (9.8 in)		

Shipping

- **Weight :** 53 kg (116.6 lbs)
- **Volume :** .41 m³ (14.48 ft³)

Installation

- **Minimum distance to illuminated surface:** 1.4 m (4.6 ft)
- **Operating position:**

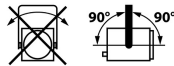

Construction

- **Housing:** Steel sheet - Aluminium
- **Colour:** Black
- **Cooling:** Variable fans
- **Maximum ambient temperature (Ta):** 40°C (104°F)
- **Maximum case temperature (Tc):** 65°C (149°F)
- **Total heat dissipation:** 1 618 BTU/h
- **Ingress Protection (IP) rating:** IP20

Electrical compatibility

- 220/230 V - 50 Hz
- 245 V - 50 Hz
- 110/120 V - 60 Hz
- 208 V - 60 Hz
- 220/230 V - 60 Hz
- 100 V - 50 Hz
- 100 V - 60 Hz
- Selector: automatic detection

Power input



- **Type:** removable power cord with compatible powerCON® TRUE1 connector (included)
- **Cable:** H07RNF 3G1.5
- **Length:** 3 m (9.8 ft)
- **Power connector:** CEE 7/7 (2P+E NF/Schuko)

Power consumption

Voltage	Frequency	Current	Power	Power factor
110 V	60 Hz	4.46 A	474 W	0.98
208 V	60 Hz	2.36 A	466 W	0.96
100 V	60 Hz	4.93 A	476 W	0.99

Power Supply Unit

- **PSU:** Internal - Electronic PSU - Flicker free with PFC
- **Control:** Local / DMX
- **Protection:** Mains: 2x 10A 5x20 T fuses /
- **Power thru:** compatible powerCON® TRUE1 - Maximum of 5 units (230 V) / 2 units (120 V)

Warranty

- **Fixture: 3 years**
See General Sales Condition on website





Approvals













Model

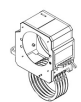















1179C	LED 420 W Followspot - 1179C Berlioz - Cool White - 7/14.5° - North american standard
--------------	---



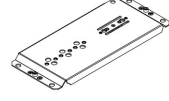

Options

FRO/SMG1PV	Heavy duty adjustable yoke equipped with TILT SpotMe sensor (G1 type)	
FCD/CLPV	Angled yoke for LED Compact followspots	
FRO/CLPV	Heavy duty adjustable yoke for LED Compact followspots (short throw)	
FC1189-2	Flight-case for Compact LED range / GT stand / accessories - Dim: 1325x600x925mm - Weight: 57,4 Kg	

Accessories

PF1011	Ø210 mm metal filter holder 6 included	
SGUP2	Universal "A" size gobo-holder (metal, glass, frosted glass) 1 included	
FO100R-2	ø100mm 2° frost optical filter with holder 1 included	
M210/2B	6 ways "boomerang" colour changer 1 included	
Fusion/RJ	Madrix Radar (RDM monitoring): Fusion RJ licence - access to all RDM parameters of RJ fixtures 1 included	
GT4000	Tripod stand with safety chain - SWL: 130 Kg - max. height: 1030 mm - Weight: 7.91 Kg	
GT4000RSM	Tripod stand with ball head rotation with security chain and SpotMe PAN sensor - SWL: 130 Kg - max. height: 1030 mm	
GT4000S	Tripod stand without safety chain - SWL: 130 Kg - max. height: 1030 mm - Weight: 8.65 Kg	
JPP	Monopod stand for overhead followspot - Weight: 3.6 Kg	
T1000	TV spigot with followspots swivel head - Weight: 1.82 Kg	
T4000	Followspot mount for Ø50mm pipe (suspension or overhead) - SWL= 100 Kg - Weight: 4.88 Kg	
T4000RSM	Followspot mount with ball head rotation and SpotMe PAN sensor - SWL = 100 Kg - Weight: 8.53 Kg	

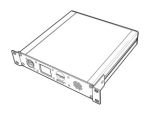
CAV700A	Double slot front cassette for 215x215mm accessories - Weight: 0.52 Kg	
FCM100R	Ø97mm 1/2 CTO correction filter (Rosco #3408) with holder	
FO100R-1	ø100mm 1° frost optical filter with holder	
FO100R-5	ø100mm 5° frost optical filter with holder	
FO120C-1	120x120mm 1° frost optical filter	
FO120C-10	120x120mm 10° frost optical filter	
FO120C-2	120x120mm 2° frost optical filter	
FO120C-5	120x120mm 5° frost optical filter	
VD120	120x120mm frosted glass	
FCD/CLPD	Angled yoke for LED Compact followspots	
FRO/CLPD	Heavy duty adjustable yoke for LED Compact followspots	
FRO/SMGPD	Heavy duty adjustable yoke equipped with TILT SpotMe sensor (G type)	
G80/3	Ø80mm horizontal chopper	
BK/E1	Extra weight kit for BK1 (0,5 Kg) - Weight: 0.5 Kg	
BK1	Followspot balancing kit (including 1 Kg counterweights) - Weight: 2.05 Kg	
Kit TELRAD	Telrad followspot sight with raiser and universal mounting kit - Weight: 1.23 Kg	
PSA1	Support plate for 2x P1FE and 1/4" accessories	
SDUP	Followspot cue sheet holder with universal mounting kit	
TCSM	SpotMe calibration tool kit	

Fusion/L	Madrix Radar (RDM monitoring): Fusion Large licence - up to 4096 non-RJ RDM fixtures - USB dongle included	
Fusion/M	Madrix Radar (RDM monitoring): Fusion Medium licence - up to 512 non-RJ RDM fixtures - USB dongle included	
Fusion/S	Madrix Radar (RDM monitoring): Fusion Small licence - up to 64 non-RJ RDM fixtures - USB dongle included	
Maestro	Maestro server for SpotMe - rackable unit: 1U - half 19" - Weight: 1.2 Kg	
SMS	SpotMe server + 2 sensor cables + flight case - Weight: 6.2 Kg	
FC1189-2/S	Flight-case for Compact LED range / GT stand / accessories - Weight: 57.4 Kg	