

# BIZET - 674CSX VW

6705X - LED 500 W - VARIABLE WHITE



- **Type:** Profile spot
- **Source:** LED 500 W - Variable White
- **Optics:** 16° to 35° zoom
- **Colour temperature:** 3000K --> 6300K
- **Standard:** 110 V North american

Profile spot

## The perfect FOH spot

The Bizet 670SX profile spot is a mighty replacement for the 2000W Halogen profile series, while offering remote adjustment of the colour temperature up to 6300K (with an output exceeding a 2500W profile spot with colour correction). It features a 500W tunable white LED source which is used at full power whatever the colour temperature chosen, guarantying high quality whites (CRI of 96-98 and TM30 Rf of 94-96). The lamp house new design makes it compatible with Robert Juliat 600SX, 713SX and 714SX Series profile lens tubes. It is ideal for all long-throw front of house applications in medium to large venues.

### Features

- **Colour Temperature (CCT):** adjustable whites from 3000 to 6300 Kelvin. Extended mode available (CCT not calibrated)
- **Multi-function double gate:** simultaneous use of gobos and iris. Sharp focus of both gobo and shutter
- **Shutter gate:** up to 8 shutters. Remove shutters for easy maintenance or tuck fully inside gate for secure transport
- **User-friendly shutter-lock system:** secures shutters' setting in any circumstances (locking efficient up to 4 shutters)
- **Universal gobo holder:** "A" size glass and metal gobo
- **Lens tube lock feature:** secures rotating lens tube against unwanted movement
- **90° rotating lens tube / gate / front accessories holder:** rotation of the projected image is always possible – no need to move the yoke
- **Internal glass filter holder:** long term use of durable coloured, dichroic or textured glass
- **Adjustable response time:** choice of fast or slow dimming for tungsten-like simulation - adjustment by DMX protocol
- **Ethernet-DMX node:** data IN through RJ45 connector; data OUT through DMX for daisy chaining
- **Universal data control:** compatible with DMX, RDM, Art-Net, sACN protocols
- **Remote setup:** all parameters can be adjusted by RDM protocol or by web interface
- **PWM adjustment:** choice of different PWM dimming frequencies - continuous mode available
- **Advanced Ethernet node functionalities:** compatible with RDM, LLRP, Zeroconf protocols
- **Local setup:** DMX address and mode, dimming curve and response time through 4-button display with automatic light switch-off
- **Dimming parameters:** choice of square or linear dimming curves
- **DMX:** 8 or 16 bit dimming, CCT, response time and strobe function
- **Easy focus reference:** graduated scale on side of the unit; fast and easy refocusing
- **Tilt reference on hanging yoke:** index for rapid re-positioning

### Optical

- **Calibrated tunable white source:** to ensure consistency between fixtures
- **Long life:** outstanding operational lifetime expectation, no need to replace lamps, low maintenance
- **Powerful tunable white:** maximum LED power guaranteed whatever the colour temperature is
- **Coated SX optical system:** double condenser optics for exceptional optical quality - Anti-Reflective coating to ensure optimal light transmission
- **Variable zoom optics:** sharp focus at every beam angle. Independent control of image size and focus. Focus handles on both sides
- **Coated zoom lenses:** all zoom lenses are anti-reflection coated (AR) to ensure a maximum transmission of light.
- **Electronic dimmer:** dimming without clipping or cut-out at low intensity levels; high quality smoothing
- **No colour shift:** colour temperature remains the same when dimming

### Construction

- **Made in France :** fully manufactured in Robert Juliat premises retaining complete control over all aspects of quality
- **Lamp house compatible with 611SX, 613SX, 614SX, 713SX and 714SX lens tubes:** lamp house only available for upgrade of existing tungsten fixtures
- **PSU:** built-in electronic flicker-free power supply for easy, plug-and-play installation
- **Power connectors:** compatible powerCON® TRUE1 IN and OUT connectors for daisy chaining
- **Silent-running cooling fans:** ideal for TV studios and opera houses
- **Electronic thermal management system:** ensures maximum performance of the system without any risk of overheating
- **3 cooling modes available:** includes a silent mode for perfect integration in concert halls
- **Bodywork:** strong sheet metal construction for durability
- **Captive knobs and handles:** additional security when working at height or in transit
- **Spare parts and accessories:** interchangeable across the tungsten, discharge or LED ranges, reducing running costs
- **Easy access to all parts:** easy cleaning and maintenance

Picture:674SX

DSEN426\_674CSX\_VW - 03/04/2025

Robert Juliat reserves the right to change or alter any of the items detailed on this page, to increase or improve manufacturing techniques without prior notice.

Robert Juliat S.A.S., 32 rue de Beaumont, 60530 Fresnoy-en-Thelle - France  
Telephone : +33 (0)3 44 26 51 89 - info@robertjuliat.fr - www.robertjuliat.com



ROBERT JULIAT

**Source** (Light quality report(s) available at the end of the document)

- **Lamp type:** LED
- **Power:** 500 W

LED specifications	Power *	Lumen output*	Colour temperature*	Life*	CRI* (min)
TVW01	500 W	31 000 lm	3000K --> 6300K	30 000 h	95

(\*) manufacturer's data

## Optics

### Characteristics

- **Type:** Zoom
- **Range:** 16° to 35° (Field angle)
- **Focal length:** 131 - 268 mm

### Gel filter

- **Shape:** Square
- **Standard size:** 191x191 mm (7.5x7.5 in)

### Gobo

- **Size:** A
- **Material:** Metal  
Glass

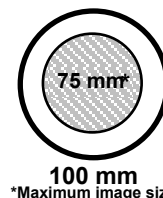

## Photometrics (Photometrics report(s) available at the end of the document)

optics: 16°-35° / Standard / 6000 K

### • Optics @ 16°

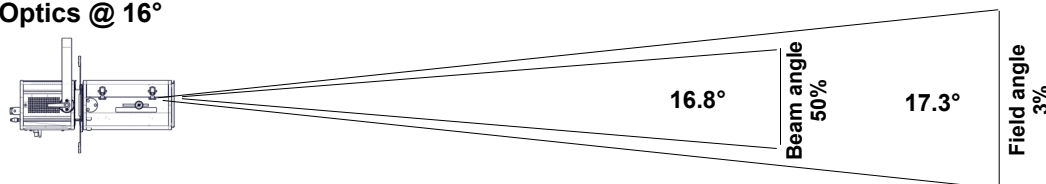

**Beam intensity**  
287 500 cd

**Field lumens**  
14 960 lm

**Efficacy**  
26 lm/W

<b>Distance</b>	5 m	10 m	15 m	20 m	25 m	30 m
<b>Diameter</b>	1.5 m	3 m	4.6 m	6.1 m	7.6 m	9.1 m
<b>Illumination</b>	12 000 lux	2 900 lux	1 300 lux	720 lux	470 lux	320 lux
<b>Distance</b>	15 ft	35 ft	50 ft	65 ft	80 ft	100 ft
<b>Diameter</b>	4.6 ft	10.6 ft	15.2 ft	19.8 ft	24.3 ft	30.4 ft
<b>Illumination</b>	1 300 fc	240 fc	120 fc	70 fc	45 fc	29 fc

### • Optics @ 35°

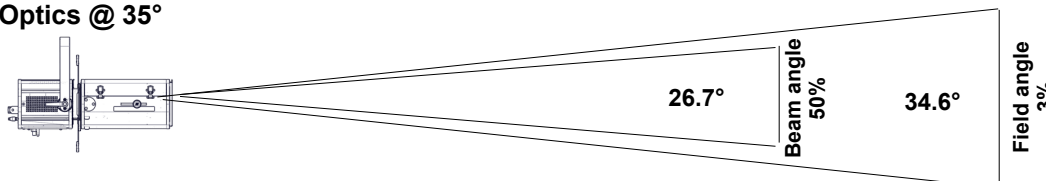

**Beam intensity**  
82 900 cd

**Field lumens**  
14 200 lm

**Efficacy**  
25 lm/W

<b>Distance</b>	5 m	10 m	15 m	20 m	25 m	30 m
<b>Diameter</b>	3.1 m	6.2 m	9.3 m	12.5 m	15.6 m	18.7 m
<b>Illumination</b>	3 350 lux	830 lux	370 lux	210 lux	140 lux	95 lux
<b>Distance</b>	15 ft	35 ft	50 ft	65 ft	80 ft	100 ft
<b>Diameter</b>	9.3 ft	21.8 ft	31.1 ft	40.5 ft	49.8 ft	62.3 ft
<b>Illumination</b>	370 fc	70 fc	34 fc	20 fc	13 fc	9 fc

## Remote control

- **Data protocol:** USITT DMX512-A  
RDM / Art-Net / sACN

- **Data IN connector:** 5 pins XLR male + etherCON RJ45
- **Data OUT connector** 5 pins XLR female



### • DMX chart:

#### Mode 1 (1 channels)

Dimmer

#### Mode 2 (6 channels)

Dimmer  
Dimmer fine  
Strobe duration  
Strobe speed  
Response time  
Control mode

#### Mode 3 (2 channels)

Dimmer  
CCT

#### Mode 4 (8 channels)

Dimmer  
Dimmer fine  
Strobe duration  
Strobe speed  
Response time  
Control mode  
CCT  
CCT fine

## Dimensions and weight

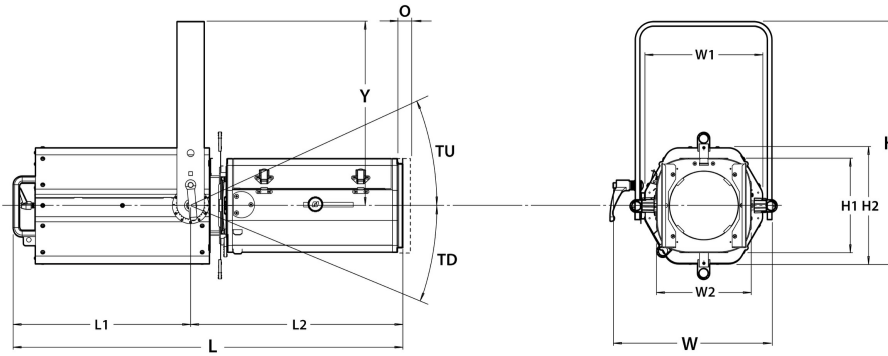

**Weight:** 20.8 kg (45.8 lbs)

Height	Length	Width	Yoke	Tilt	Option
H= 535 mm (21.1 in)	L= 855 mm (33.7 in)	W= 347 mm (13.7 in)	Y= 405 mm (15.9 in)	TD= 90°	O= 25 mm (1 in)
H'= 445 mm (17.5 in)	L1= 390 mm (15.4 in)	W1= 259 mm (10.2 in)	Y'= 315 mm (12.4 in)		
H1= 208 mm (8.2 in)	L2= 465 mm (18.3 in)	W2= 208 mm (8.2 in)			
H2= 259 mm (10.2 in)					

## Shipping

- **Weight :** 24 kg (52.8 lbs)
- **Volume :** .13 m<sup>3</sup> (4.73 ft<sup>3</sup>)

## Installation

- **Minimum distance to illuminated surface:** 1.1 m ( 3.6 ft )
- **Operating position:**

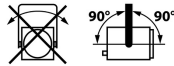

## Construction

- **Housing:** Steel sheet - Aluminium
- **Colour:** Black
- **Cooling:** Low noise variable fan
- **Maximum ambient temperature (Ta):** 40°C (104°F)
- **Maximum case temperature (Tc):** 90°C (194°F)
- **Total heat dissipation:** 2 068 BTU/h
- **Ingress Protection (IP) rating:** IP20

## Electrical compatibility

- 220/230 V - 50 Hz
- 220/230 V - 60 Hz
- 245 V - 50 Hz
- 100 V - 50 Hz
- 110/120 V - 60 Hz
- 100 V - 60 Hz
- 208 V - 60 Hz
- Selector: automatic detection

## Power input



- **Type:** removable power cord with compatible powerCON® TRUE1 connector (included)
- **Cable:** 14 AWG SJ type (UL/CSA)
- **Length:** 1.5 m (4.9 ft)
- **Power connector:** without connector

## Power consumption

Voltage	Frequency	Current	Power	Power factor
110 V	60 Hz	5.6 A	606 W	0.98
208 V	60 Hz	2.96 A	593 W	0.96
100 V	60 Hz	6.19 A	610 W	0.99

## Power Supply Unit

- **PSU:** Internal - Electronic PSU - Flicker free with PFC
- **Control:** Local / DMX
- **Protection:** Mains: 2x 10A 1P1D breaker - UL /
- **Power thru:** compatible powerCON® TRUE1 - Maximum of 5 units (230 V) / 2 units (120 V)

## Warranty

- **Fixture: 3 years**
- See General Sales Condition on website

## Approvals



## Acoustics

- **Noise level:** < 30,2 dB(A)















## Model

<b>674CSX VW</b>	LED 500 W - Variable White Profile spot - 674CSX VW Bizet - 16/35° - North american standard
------------------	----------------------------------------------------------------------------------------------

## Options

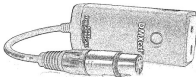
<b>CAV600C</b>	Double slot front cassette for 191x191mm (7-1/2") accessories	
----------------	---------------------------------------------------------------	-------------------------------------------------------------------------------------

## Accessories

<b>D8</b>	Shutter for SX series <b>4 included</b>	
<b>SGUX</b>	Universal "A" size gobo-holder (metal, glass, frosted glass) <b>1 included</b>	
<b>FO100-10</b>	Ø97mm optical filter for coloured LED source - typ 10 <b>1 included</b>	
<b>IWSX755</b>	Drop-in iris (monoplane) with holder - Weight: 0.26 Kg	
<b>D8</b>	Shutter for SX series	
<b>G500</b>	180x180mm safety grid	
<b>CAV600AC</b>	Double slot front cassette for 191x191mm (7-1/2") accessories - Weight: 0.45 Kg	
<b>RPF613</b>	180x180mm front extension cassette for 215x215mm accessories without fan (recommended for dark colours on 613SX/663SX) - Weight: 1.5 Kg	
<b>RPF613E</b>	180x180mm front extension cassette for 245x245mm accessories without fan (recommended for dark colours on 613SX/663SX)	
<b>VD120</b>	120x120mm frosted glass	
<b>DMXcat</b>	Bluetooth DMX/RDM Multifunction test tool - City Theatrical DMXcat®	
<b>876</b>	Hook clamp 40x10mm with 28mm M10 screw for Ø35 to 50mm pipes - SWL: 50Kg - Weight: 1.25 Kg	
<b>880</b>	Hook clamp 40x10mm with 28mm M10 screw for Ø50 to 63mm pipes - SWL: 50Kg - Weight: 1.36 Kg	
<b>CS2</b>	Safety cable Ø3 mm L= 600mm - SWL: 75 Kg	

• Optics @ 16°

Field lumens	Beam lumens	Efficacy	Beam intensity	CCT	Delta uv
14 960 Lm	14 670 Lm	26 Lm/W	287 500 Cd	6 150 K	0.0009

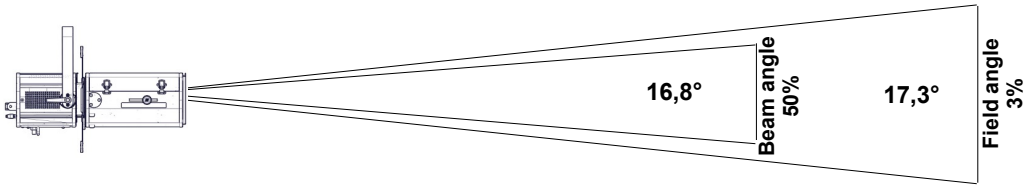

<b>Distance</b>	5 m	10 m	15 m	20 m	25 m	30 m
<b>Field diameter</b>	1,5 m	3 m	4,6 m	6,1 m	7,6 m	9,1 m
<b>Illumination</b>	12 000 lux	2 900 lux	1 300 lux	720 lux	470 lux	320 lux
<b>Distance</b>	15 ft	35 ft	50 ft	65 ft	80 ft	100 ft
<b>Field diameter</b>	4,6 ft	10,6 ft	15,2 ft	19,8 ft	24,3 ft	30,4 ft
<b>Illumination</b>	1 300 fc	240 fc	120 fc	70 fc	45 fc	29 fc

• Optics @ 35°

Field lumens	Beam lumens	Efficacy	Beam intensity	CCT	Delta uv
14 200 Lm	10 500 Lm	25 Lm/W	82 900 Cd	5 970 K	0.0009

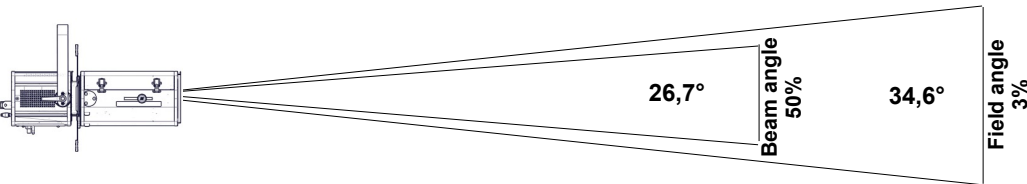

<b>Distance</b>	5 m	10 m	15 m	20 m	25 m	30 m
<b>Field diameter</b>	3,1 m	6,2 m	9,3 m	12,5 m	15,6 m	18,7 m
<b>Illumination</b>	3 350 lux	830 lux	370 lux	210 lux	140 lux	95 lux
<b>Distance</b>	15 ft	35 ft	50 ft	65 ft	80 ft	100 ft
<b>Field diameter</b>	9,3 ft	21,8 ft	31,1 ft	40,5 ft	49,8 ft	62,3 ft
<b>Illumination</b>	370 fc	70 fc	34 fc	20 fc	13 fc	9 fc

• Optics @ 16°

Field lumens	Beam lumens	Efficacy	Beam intensity	CCT	Delta uv
11 000 Lm	10 770 Lm	19 Lm/W	209 900 Cd	3 240 K	-0.0008

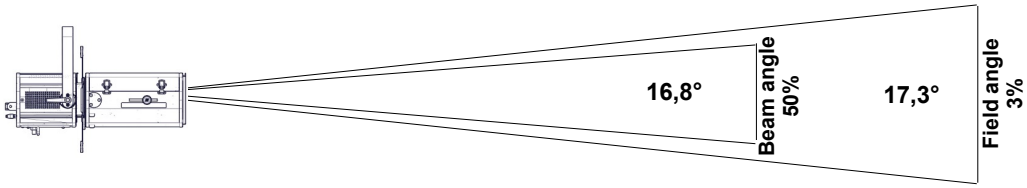

<b>Distance</b>	5 m	10 m	15 m	20 m	25 m	30 m
<b>Field diameter</b>	1,5 m	3 m	4,6 m	6,1 m	7,6 m	9,1 m
<b>Illumination</b>	8 400 lux	2 100 lux	940 lux	530 lux	340 lux	240 lux
<b>Distance</b>	15 ft	35 ft	50 ft	65 ft	80 ft	100 ft
<b>Field diameter</b>	4,6 ft	10,6 ft	15,2 ft	19,8 ft	24,3 ft	30,4 ft
<b>Illumination</b>	940 fc	180 fc	85 fc	50 fc	33 fc	21 fc

• Optics @ 35°

Field lumens	Beam lumens	Efficacy	Beam intensity	CCT	Delta uv
10 390 Lm	7 670 Lm	18 Lm/W	60 900 Cd	3 190 K	-0.0008

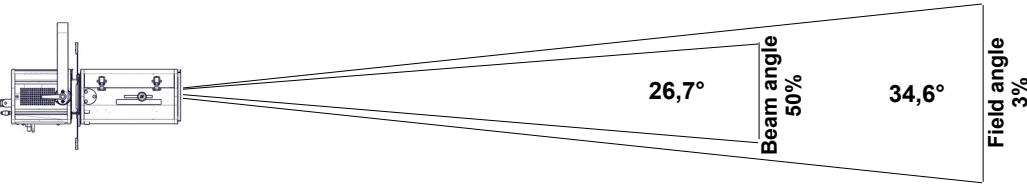

<b>Distance</b>	5 m	10 m	15 m	20 m	25 m	30 m
<b>Field diameter</b>	3,1 m	6,2 m	9,3 m	12,5 m	15,6 m	18,7 m
<b>Illumination</b>	2 450 lux	610 lux	280 lux	160 lux	100 lux	70 lux
<b>Distance</b>	15 ft	35 ft	50 ft	65 ft	80 ft	100 ft
<b>Field diameter</b>	9,3 ft	21,8 ft	31,1 ft	40,5 ft	49,8 ft	62,3 ft
<b>Illumination</b>	280 fc	50 fc	25 fc	15 fc	10 fc	7 fc

• Optics @ 15°

Field lumens	Beam lumens	Efficacy	Beam intensity	CCT	Delta uv
14 700 Lm	14 470 Lm	26 Lm/W	364 900 Cd	6 210 K	0.0016

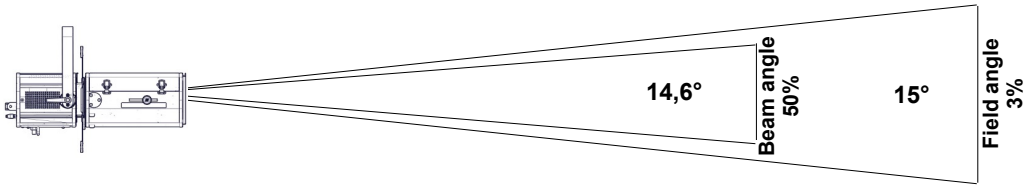

<b>Distance</b>	5 m	10 m	15 m	20 m	25 m	30 m
<b>Field diameter</b>	1,3 m	2,6 m	3,9 m	5,3 m	6,6 m	7,9 m
<b>Illumination</b>	15 000 lux	3 650 lux	1 650 lux	920 lux	590 lux	410 lux
<b>Distance</b>	15 ft	35 ft	50 ft	65 ft	80 ft	100 ft
<b>Field diameter</b>	3,9 ft	9,2 ft	13,2 ft	17,1 ft	21,1 ft	26,3 ft
<b>Illumination</b>	1 650 fc	300 fc	150 fc	90 fc	60 fc	37 fc

• Optics @ 40°

Field lumens	Beam lumens	Efficacy	Beam intensity	CCT	Delta uv
13 270 Lm	9 670 Lm	23 Lm/W	65 000 Cd	5 960 K	0.0018

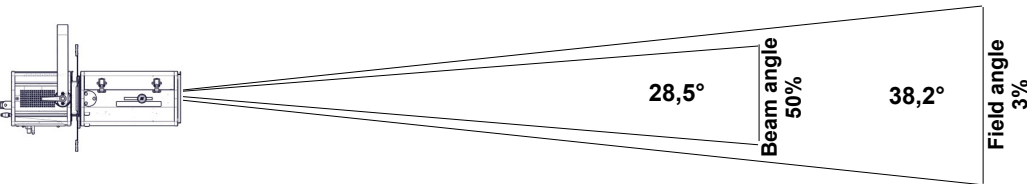

<b>Distance</b>	5 m	10 m	15 m	20 m	25 m	30 m
<b>Field diameter</b>	3,5 m	6,9 m	10,4 m	13,9 m	17,3 m	20,8 m
<b>Illumination</b>	2 650 lux	660 lux	290 lux	170 lux	110 lux	75 lux
<b>Distance</b>	15 ft	35 ft	50 ft	65 ft	80 ft	100 ft
<b>Field diameter</b>	10,4 ft	24,2 ft	34,6 ft	45 ft	55,4 ft	69,3 ft
<b>Illumination</b>	290 fc	55 fc	27 fc	16 fc	11 fc	7 fc

• Optics @ 15°

Field lumens	Beam lumens	Efficacy	Beam intensity	CCT	Delta uv
10 830 Lm	10 660 Lm	19 Lm/W	270 200 Cd	3 250 K	-0.0001

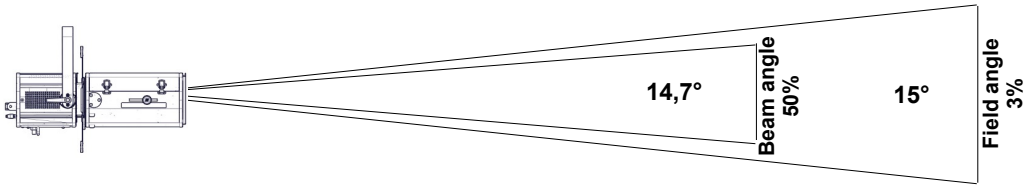

Distance	5 m	10 m	15 m	20 m	25 m	30 m
Field diameter	1,3 m	2,6 m	3,9 m	5,3 m	6,6 m	7,9 m
Illumination	11 000 lux	2 750 lux	1 250 lux	680 lux	440 lux	310 lux
Distance	15 ft	35 ft	50 ft	65 ft	80 ft	100 ft
Field diameter	3,9 ft	9,2 ft	13,2 ft	17,1 ft	21,1 ft	26,3 ft
Illumination	1 250 fc	230 fc	110 fc	65 fc	43 fc	28 fc

• Optics @ 40°

Field lumens	Beam lumens	Efficacy	Beam intensity	CCT	Delta uv
9 790 Lm	7 080 Lm	17 Lm/W	48 500 Cd	3 180 K	-0.0002

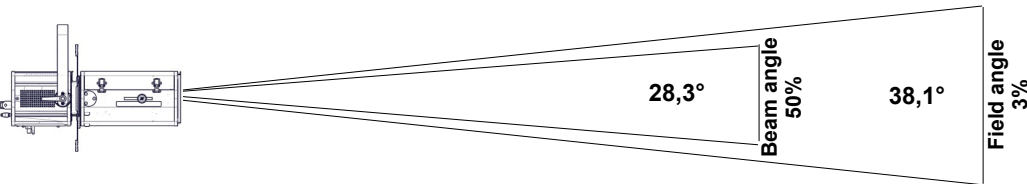

Distance	5 m	10 m	15 m	20 m	25 m	30 m
Field diameter	3,5 m	6,9 m	10,4 m	13,8 m	17,3 m	20,7 m
Illumination	1 950 lux	490 lux	220 lux	130 lux	80 lux	55 lux
Distance	15 ft	35 ft	50 ft	65 ft	80 ft	100 ft
Field diameter	10,4 ft	24,2 ft	34,5 ft	44,9 ft	55,2 ft	69,1 ft
Illumination	220 fc	40 fc	20 fc	12 fc	8 fc	5 fc



CCT	DeltaUV	CRI Ra	CRI R9	CQS Qa	TM30-18 Rf	TM30-18 Rg	TLCI	SSI [3200]
3 200K	-0.0007	98	97	98	96	102	99	86

CRI - CIE Colour Rendering Index

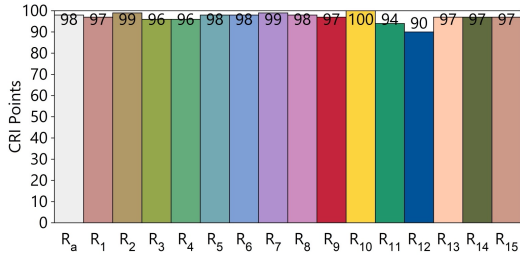

TLCI - Television Lighting Consistency Index

Test : CCT = P3200 (-0.1)  
 TLCI-2012 : 99 (P3200)

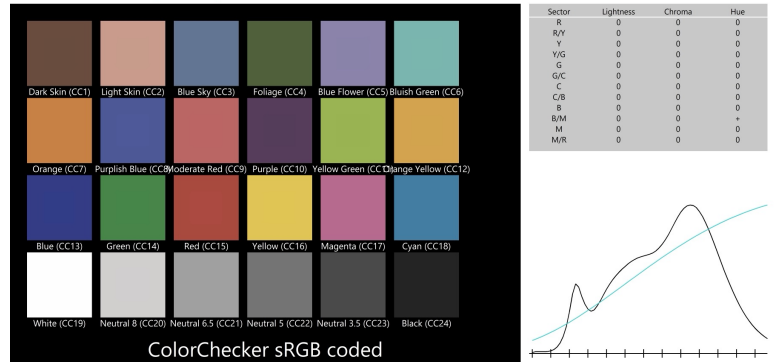

CQS - NIST Colour Quality Scale

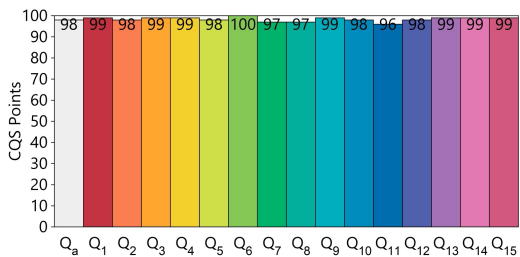

ANSI/IES TM-30-18 Colour Rendition Report

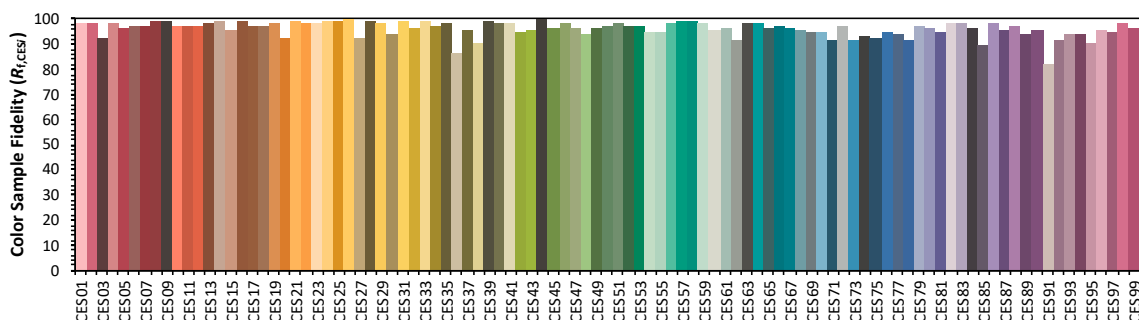
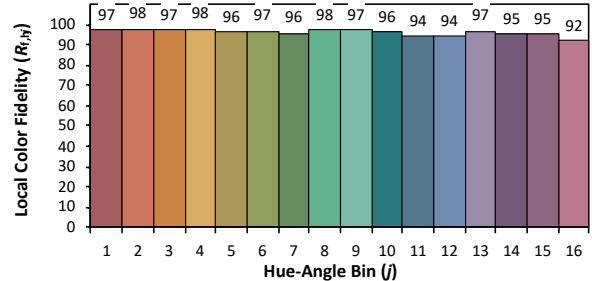
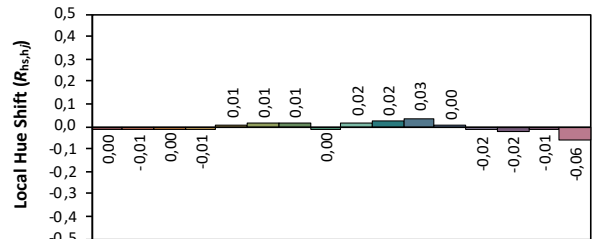
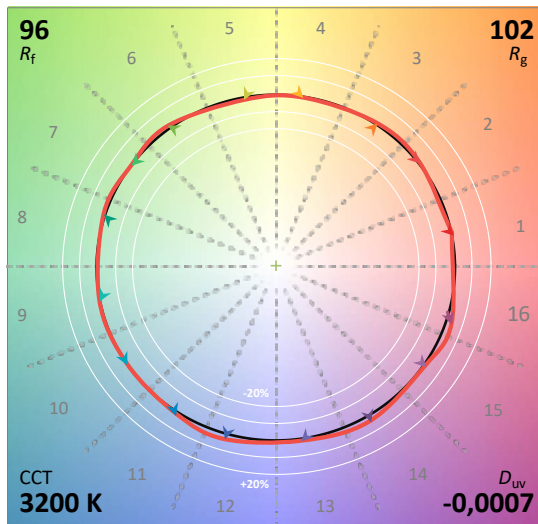
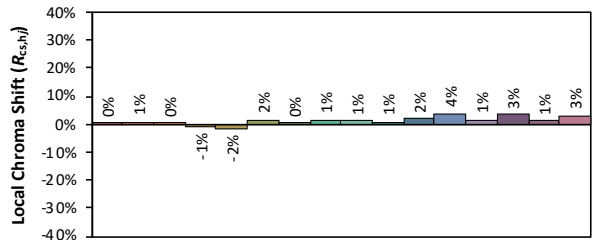
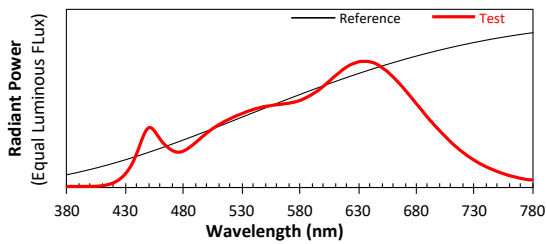

CCT	DeltaUV	CRI Ra	CRI R9	CQS Qa	TM30-18 Rf	TM30-18 Rg	TLCI	SSI [6002]
6 000K	0.0007	97	97	94	94	102	99	75

CRI - CIE Colour Rendering Index

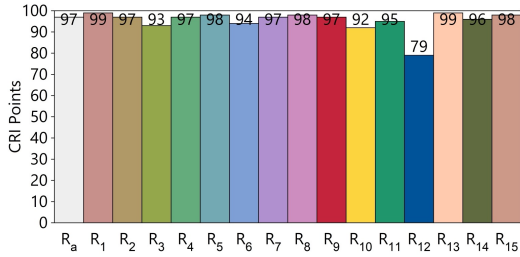

TLCI - Television Lighting Consistency Index

Test : CCT = D6002 (-0.5)  
 TLCI-2012 : 99 (D6002)



CQS - NIST Colour Quality Scale

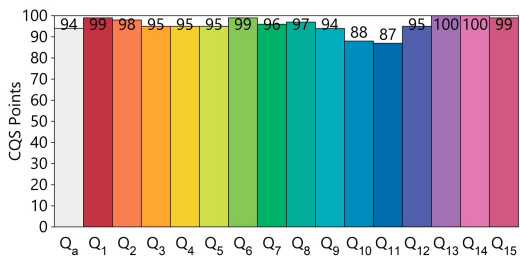

ANSI/IES TM-30-18 Colour Rendition Report

