

# BIZET - 673CSX VW

670SX - LED 500 W - VARIABLE WHITE



- **Type:** Profile spot
- **Source:** LED 500 W - Variable White
- **Optics:** 28° to 54° zoom
- **Colour temperature:** 3000K --> 6300K
- **Standard:** 110 V North american

Profile spot

## The perfect FOH spot

The Bizet 670SX profile spot is a mighty replacement for the 2000W Halogen profile series, while offering remote adjustment of the colour temperature up to 6300K ( with an output exceeding a 2500W profile spot with colour correction). It features a 500W tunable white LED source which is used at full power whatever the colour temperature chosen, guarantying high quality whites (CRI of 96-98 and TM30 Rf of 94-96). The lamp house new design makes it compatible with Robert Juliat 600SX and 700SX Series profile lens tubes. It is ideal for all long-throw front of house applications in medium to large venues.

### Features

- **Colour Temperature (CCT):** adjustable whites from 3000 to 6300 Kelvin. Extended mode available (CCT not calibrated)
- **Multi-function double gate:** simultaneous use of gobos and iris. Sharp focus of both gobo and shutter
- **Shutter gate:** up to 8 shutters. Remove shutters for easy maintenance or tuck fully inside gate for secure transport
- **User-friendly shutter-lock system:** secures shutters' setting in any circumstances (locking efficient up to 4 shutters)
- **Universal gobo holder:** "A" size glass and metal gobo
- **Lens tube lock feature:** secures rotating lens tube against unwanted movement
- **90° rotating lens tube / gate / front accessories holder:** rotation of the projected image is always possible – no need to move the yoke
- **Internal glass filter holder:** long term use of durable coloured, dichroic or textured glass
- **Adjustable response time:** choice of fast or slow dimming for tungsten-like simulation - adjustment by DMX protocol
- **Ethernet-DMX node:** data IN through RJ45 connector; data OUT through DMX for daisy chaining
- **Universal data control:** compatible with DMX, RDM, Art-Net, sACN protocols
- **Remote setup:** all parameters can be adjusted by RDM protocol or by web interface
- **PWM adjustment:** choice of different PWM dimming frequencies - continuous mode available
- **Advanced Ethernet node functionalities:** compatible with RDM, LLRP, Zeroconf protocols
- **Local setup:** DMX address and mode, dimming curve and response time through 4-button display with automatic light switch-off
- **DMX:** 8 or 16 bit dimming, CCT and strobe function
- **Dimming parameters:** choice of square or linear dimming curves
- **Easy focus reference:** graduated scale on side of the unit; fast and easy refocusing
- **Tilt reference on hanging yoke:** index for rapid re-positioning

### Optical

- **Calibrated tunable white source:** to ensure consistency between fixtures
- **Long life:** outstanding operational lifetime expectation, no need to replace lamps, low maintenance
- **Powerful tunable white:** maximum LED power guaranteed whatever the colour temperature is
- **Coated SX optical system:** double condenser optics for exceptional optical quality - Anti-Reflective coating to ensure optimal light transmission
- **Variable zoom optics:** sharp focus at every beam angle. Independent control of image size and focus. Focus handles on both sides
- **Coated zoom lenses:** all zoom lenses are anti-reflection coated (AR) to ensure a maximum transmission of light.
- **Electronic dimmer:** dimming without clipping or cut-out at low intensity levels; high quality smoothing
- **No colour shift:** colour temperature remains the same when dimming

### Construction

- **Made in France :** fully manufactured in Robert Juliat premises retaining complete control over all aspects of quality
- **Lamp house compatible with 611SX, 613SX, 614SX, 713SX and 714SX lens tubes:** lamp house only available for upgrade of existing tungsten fixtures
- **PSU:** built-in electronic flicker-free power supply for easy, plug-and-play installation
- **Power connectors:** neutriK® powerCON TRUE1 TOP IN and OUT connectors for daisy chaining
- **Silent-running cooling fans:** ideal for TV studios and opera houses
- **Electronic thermal management system:** ensures maximum performance of the system without any risk of overheating
- **3 cooling modes available:** includes silent mode for perfect integration in concert halls
- **Bodywork:** strong sheet metal construction for durability
- **Captive knobs and handles:** additional security when working at height or in transit
- **Spare parts and accessories:** interchangeable across the tungsten, discharge or LED ranges, reducing running costs
- **Easy access to all parts:** easy cleaning and maintenance

Picture:673SX

DSEN420\_673CSX\_VW\_Preliminary - 31/07/2024 - Preliminary data  
Robert Juliat reserves the right to change or alter any of the items detailed on this page, to increase or improve manufacturing techniques without prior notice.  
Robert Juliat S.A.S., 32 rue de Beaumont, 60530 Fresnoy-en-Thelle - France  
Telephone : +33 (0)3 44 26 51 89 - info@robertjuliat.fr - www.robertjuliat.com



ROBERT JULIAT

**Source** (Light quality report(s) available at the end of the document)

- **Lamp type:** LED
- **Power:** 500 W

LED specifications	Power *	Lumen output*	Colour temperature*
TVW01	500 W		3000K --> 6300K

(\*) manufacturer's data

## Optics

### Characteristics

- **Type:** Zoom
- **Range:** 28° to 54° (Field angle)
- **Focal length:** 86 - 160 mm

### Gel filter

- **Shape:** Square
- **Standard size:** 191x191 mm (7.5x7.5 in)

### Gobo

- **Size:** A
- **Material:** Metal  
Glass

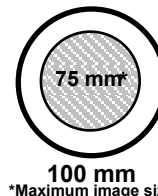

## Photometrics (Photometrics report(s) available at the end of the document)

optics: 28°-54° / Standard / 6000 K

### • Optics @ 28°

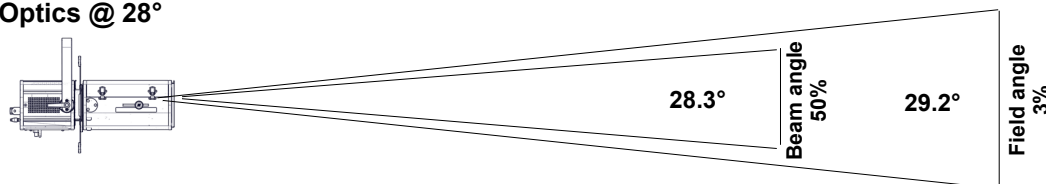

**Beam intensity**  
99 600 cd

**Field lumens**  
15 130 lm

**Efficacy**  
26 lm/W

<b>Distance</b>	3 m	5 m	7 m	10 m	12 m	15 m
<b>Diameter</b>	1.6 m	2.6 m	3.6 m	5.2 m	6.3 m	7.8 m
<b>Illumination</b>	11 500 lux	4 000 lux	2 050 lux	1 000 lux	700 lux	450 lux
<b>Distance</b>	10 ft	15 ft	25 ft	35 ft	40 ft	50 ft
<b>Diameter</b>	5.2 ft	7.8 ft	13 ft	18.2 ft	20.8 ft	26 ft
<b>Illumination</b>	1 000 fc	450 fc	160 fc	85 fc	65 fc	40 fc

### • Optics @ 54°

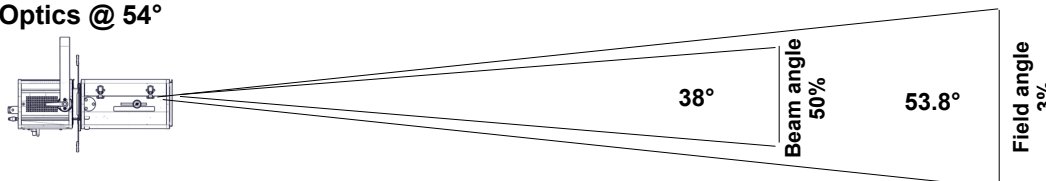

**Beam intensity**  
37 000 cd

**Field lumens**  
15 400 lm

**Efficacy**  
27 lm/W

<b>Distance</b>	3 m	5 m	7 m	10 m	12 m	15 m
<b>Diameter</b>	3 m	5.1 m	7.1 m	10.1 m	12.2 m	15.2 m
<b>Illumination</b>	4 150 lux	1 500 lux	760 lux	380 lux	260 lux	170 lux
<b>Distance</b>	10 ft	15 ft	25 ft	35 ft	40 ft	50 ft
<b>Diameter</b>	10.1 ft	15.2 ft	25.4 ft	35.5 ft	40.6 ft	50.7 ft
<b>Illumination</b>	380 fc	170 fc	60 fc	31 fc	24 fc	15 fc

## Remote control

- **Data protocol:** USITT DMX512-A  
RDM / Art-Net / sACN

- **Data IN connector:** 5 pins XLR mâle + etherCON RJ45
- **Data OUT connector:** 5 pins XLR femelle



### • DMX chart:

#### Mode 1 (1 channels)

Dimmer

#### Mode 2 (6 channels)

Dimmer  
Dimmer fine  
Strobe duration  
Strobe speed  
Response time  
Control mode

#### Mode 3 (2 channels)

Dimmer  
CCT

#### Mode 4 (6 channels)

Dimmer  
Dimmer fine  
Strobe duration  
Strobe speed  
Response time  
Control mode  
CCT  
CCT fine

## Dimensions and weight

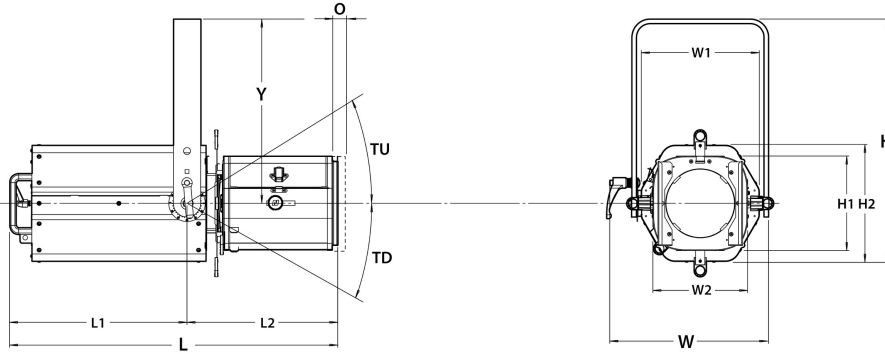

**Weight:** 19.2 kg (42.2 lbs)

Height	Length	Width	Yoke	Tilt
H= 535 mm (21.1 in)	L= 724 mm (28.5 in)	W= 347 mm (13.7 in)	Y= 405 mm (15.9 in)	TD= 90°
H'= 445 mm (17.5 in)	L1= 390 mm (15.4 in)	W1= 259 mm (10.2 in)	Y'= 315 mm (12.4 in)	
H1= 208 mm (8.2 in)	L2= 334 mm (13.1 in)	W2= 208 mm (8.2 in)		
H2= 259 mm (10.2 in)				

## Shipping

- **Weight :**
- **Volume :**

## Installation

- **Minimum distance to illuminated surface:** 0.6 m ( 2.0 ft )
- **Operating position:**

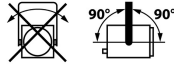

## Construction

- **Housing:** Steel sheet - Aluminium
- **Colour:** Black
- **Cooling:** Low noise variable fan
- **Maximum ambient temperature (Ta):** 40°C (104°F)
- **Maximum case temperature (Tc):** 90°C (194°F)
- **Total heat dissipation:** 2 068 BTU/h
- **Ingress Protection (IP) rating:** IP20

## Electrical compatibility

- 220/230 V - 50 Hz
- 245 V - 50 Hz
- 110/120 V - 60 Hz
- 208 V - 60 Hz
- 220/230 V - 60 Hz
- 100 V - 50 Hz
- 100 V - 60 Hz
- Selector: automatic detection

## Power input



- **Type:** removable power cord with Neutrik powerCON TRUE1 TOP connector (included)
- **Cable:** 14 AWG SJ type (UL/CSA)
- **Length:** 1.5 m (4.9 ft)
- **Power connector:** without connector

## Power consumption

Voltage	Frequency	Current	Power	Power factor
110 V	60 Hz	5.6 A	606 W	0.98
208 V	60 Hz	2.96 A	593 W	0.96
100 V	60 Hz	6.19 A	610 W	0.99

## Power Supply Unit

- **PSU:** Internal - Electronic PSU - Flicker free with PFC
- **Control:** Local / DMX
- **Protection:** Mains: 2x 10A 1P1D breaker - UL /
- **Power thru:** Neutrik powerCON TRUE1 TOP - Maximum of 5 units (230 V) / 2 units (120 V)

## Approvals



## Warranty

- **Fixture: 3 years**
- See General Sales Condition on website













## Model

<b>673CSX VW</b>	LED 500 W - Variable White Profile spot - 673CSX VW Bizet - 28/54° - North american standard
------------------	--

## Options

<b>CAV600C</b>	Double slot front cassette for 191x191mm (7-1/2") accessories	
----------------	---	---

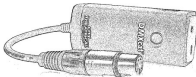
## Accessories

<b>D8</b>	Shutter for SX series <b>4 included</b>	
<b>SGUX</b>	Universal "A" size gobo-holder (metal, glass, frosted glass) <b>1 included</b>	
<b>FO100-10</b>	Ø97mm optical filter for coloured LED source - typ 10 <b>1 included</b>	
<b>IWSX755</b>	Drop-in iris (monoplane) with holder - Weight: 0.26 Kg	
<b>D8</b>	Shutter for SX series	
<b>G500</b>	180x180mm safety grid	
<b>CAV600AC</b>	Double slot front cassette for 191x191mm (7-1/2") accessories - Weight: 0.45 Kg	
<b>RPF613</b>	180x180mm front extension cassette for 215x215mm accessories without fan (recommended for dark colours on 613SX/663SX) - Weight: 1.5 Kg	
<b>RPF613E</b>	180x180mm front extension cassette for 245x245mm accessories without fan (recommended for dark colours on 613SX/663SX)	
<b>VD120</b>	120x120mm frosted glass	
<b>DMXcat</b>	Bluetooth DMX/RDM Multifunction test tool - City Theatrical DMXcat®	
<b>876</b>	Hook clamp 40x10mm with 28mm M10 screw for Ø35 to 50mm pipes - SWL: 50Kg - Weight: 1.25 Kg	
<b>880</b>	Hook clamp 40x10mm with 28mm M10 screw for Ø50 to 63mm pipes - SWL: 50Kg - Weight: 1.36 Kg	
<b>CS2</b>	Safety cable Ø3 mm L= 600mm - SWL: 75 Kg	