

ZEP2 - 643CSX2 WW

6405X - LED 150 W



- **Type:** Profile spot
- **Source:** LED 150 W
- **Optics:** 28° to 54° zoom
- **Colour temperature:** Warm white
- **Standard:** 110 V North american

Profile spot

The LED profile combining power and optical excellence

The RJ ZEP2 profile incorporates an innovative and powerful 150 W LED engine, designed to offer a higher light quality and output - equivalent to a 1000 W tungsten profile spot - together with very low power consumption. Designed with Robert Juliat's trademark qualities of ergonomic perfection, optical and mechanical excellence, ZEP2 features an excellent colour rendering index and suit every application from the smallest theatre to the largest spectacular.

Features

- **Multi-function double gate:** simultaneous use of gobos and iris. Sharp focus of both gobo and shutter
- **Shutter gate:** up to 8 shutters. Remove shutters for easy maintenance or tuck fully inside gate for secure transport
- **User-friendly shutter-lock system:** secures shutters' setting in any circumstances (locking efficient up to 4 shutters)
- **Universal gobo holder:** "A" size glass and metal gobo
- **90° rotating lens tube / gate / front accessories holder:** rotation of the projected image is always possible – no need to move the yoke
- **Internal glass filter holder:** long term use of durable coloured, dichroic or textured glass
- **Remote setup:** all parameters can be adjusted by RDM protocol
- **Adjustable response time:** choice of fast or slow dimming for tungsten-like simulation
- **DMX:** 8 or 16 bit dimming and strobe function
- **Local setup:** dMX address and mode, dimming curve and response time through 4-button display with automatic light switch-off
- **Control:** local, DMX, wireless DMX (option)
- **Easy focus reference:** graduated scale on side of the unit; fast and easy refocusing
- **Tilt reference on hanging yoke:** index for rapid re-positioning

Optical

- **Long life:** outstanding operational lifetime expectation, no need to replace lamps, low maintenance
- **SX optical system:** double condenser optics for exceptional optical quality
- **Coated double condenser optical system:** ensures optimal light transmission
- **Variable zoom optics:** sharp focus at every beam angle. Independent control of image size and focus. Focus handles on both sides
- **Electronic dimmer:** dimming without clipping or cut-out at low intensity levels; high quality smoothing
- **No colour shift:** colour temperature remains the same when dimming

Construction

- **Made in France :** fully manufactured in Robert Juliat premises retaining complete control over all aspects of quality
- **PSU:** built-in electronic flicker-free power supply for easy, plug-and-play installation
- **Power connectors:** neutriK® powerCON TRUE1 TOP IN and OUT connectors for daisy chaining
- **Silent-running cooling fans:** ideal for TV studios and opera houses
- **Electronic thermal management system:** ensures maximum performance of the system without any risk of overheating
- **Bodywork:** strong sheet metal construction for durability
- **Captive knobs and handles:** additional security when working at height or in transit
- **Spare parts and accessories:** interchangeable across the tungsten, discharge or LED ranges, reducing running costs
- **Easy access to all parts:** easy cleaning and maintenance

Picture:643SX

DSEN346_643CSX2_WW - 07/08/2020

Robert Juliat reserves the right to change or alter any of the items detailed on this page, to increase or improve manufacturing techniques without prior notice.

Robert Juliat S.A.S., 32 rue de Beaumont, 60530 Fresnoy-en-Thelle - France
Telephone : +33 (0)3 44 26 51 89 - fax : +33 (0)3 44 26 90 79 - info@robertjuliat.fr
www.robertjuliat.com



ROBERT JULIAT

Source

- **Lamp type:** LED
- **Power:** 150 W

LED specifications	Power *	Lumen output*	Colour temperature*	Life*	CRI* (min)
SUHD60/2 V3 WW (RJ / Osram)	150 W	14 190 lm	3000K	100 000 h	92

(*) manufacturer's data

Optics

Characteristics

- **Type:** Zoom
- **Beam range:** 28° to 54°
- **Focal length:** 79 - 160 mm

Gel filter

- **Shape:** Square
- **Standard size:** 191x191 mm (7.5x7.5 in)

Gobo

- **Size:** A
- **Material:** Metal
Glass
Plastic



100 mm

*Maximum image size

Photometrics

with source

Remote control

- **Data protocol:** USITT DMX512-A
RDM

• DMX chart:

Mode 1 (1 channels)

Dimmer

Mode 2 (4 channels)

Dimmer
Dimmer fine
-
Strobe

Mode 3 (5 channels)

Dimmer
Dimmer fine
-
Strobe
Dimmer master

- **Data IN connector:** 5 pins XLR male
- **Data OUT connector:** 5 pins XLR femelle



Dimensions and weight

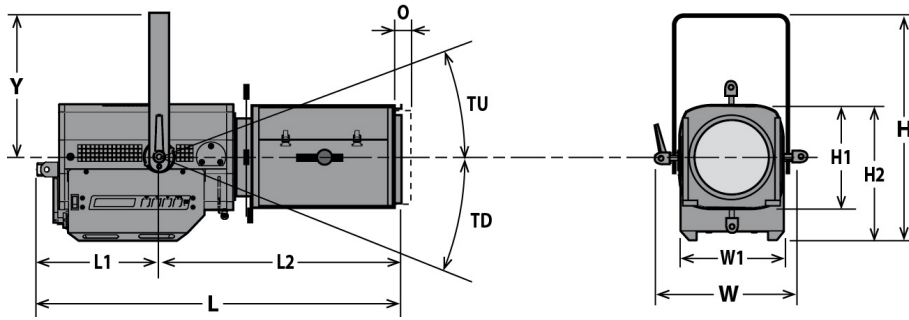

Weight: 15.3 kg (33.7 lbs)

Height	Length	Width	Yoke	Tilt	Option
H= 447 mm (17.6 in)	L= 682 mm (26.9 in)	W= 330 mm (13 in)	Y= 280 mm (11 in)	TU= 60°	O= 25 mm (1 in)
H1= 208 mm (8.2 in)	L1= 241 mm (9.5 in)	W1= 208 mm (8.2 in)		TD= 90°	
H2= 268 mm (10.6 in)	L2= 441 mm (17.4 in)				

Shipping

- **Weight :** 18.2 kg (40 lbs)
- **Volume :** .13 m³ (4.59 ft³)

Installation

- **Minimum distance to illuminated surface:** 0.4 m (1.1 ft)
- **Operating position:**

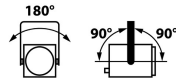

Construction

- **Housing:** Steel sheet - Aluminium
- **Colour:** Black
- **Cooling:** Low noise variable fan
- **Maximum ambient temperature (Ta):** 40°C (104°F)
- **Maximum case temperature (Tc):** 65°C (149°F)
- **Total heat dissipation:** 631 BTU/h
- **Protection rating:** 20

Electrical compatibility

- 220/230 V - 50 Hz
- 245 V - 50 Hz
- 110/120 V - 60 Hz
- 208 V - 60 Hz
- 220/230 V - 60 Hz
- 100 V - 50 Hz
- 100 V - 60 Hz
- Selector: automatic detection

Power input



- **Type:** removable power cord with Neutrik powerCON TRUE1 TOP connector (included)
- **Cable:** 14 AWG SJ type (UL/CSA)
- **Length:** 1.5 m (4.9 ft)
- **Power connector:** without connector

Power consumption

Voltage	Frequency	Current	Power	Power factor
230 V	50 Hz	0.8 A	185 W	0.95
120 V	60 Hz	1.5 A	185 W	0.98
100 V	60 Hz	1.8 A	185 W	98

Power Supply Unit

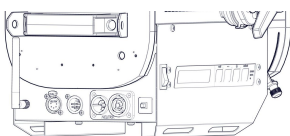

- **PSU:** Internal - Electronic PSU - Flicker free with PFC
- **Control:** Local / DMX
- **Protection:** Mains: 4A 1P1D breaker - UL /
- **Power thru:** Neutrik powerCON TRUE1 TOP - Maximum of 19 units (230 V) / 10 units (120 V)

Warranty

- **Fixture: 3 years - Source: 5 years**
See General Sales Condition on website

Approvals





Acoustics

- **Noise level:** < 22,7 dB(A)









Model

643CSX2 WW	LED 150 W Profile spot - 643CSX2 WW ZEP2 - Warm White - 28/54° - North american standard
-------------------	--

Options

CAV600C	Double slot front cassette for 191x191mm (7-1/2") accessories	
W-DMX/Z	W-DMX wireless DMX	

Accessories

D8	Shutter for SX series 4 included	
SGUX	Universal "A" size gobo-holder (metal, glass, frosted glass) 1 included	
IWSX755	Drop-in iris (monoplane) with holder - Poids: 0.26 Kg	
CAV600AC	Double slot front cassette for 191x191mm (7-1/2") accessories - Poids: 0.45 Kg	
VD120	120x120mm frosted glass	
FCD600	Angled yoke	
876	Hook clamp 40x10mm with 28mm M10 screw for Ø35 to 50mm pipes - SWL: 50Kg - Poids: 1.25 Kg	
880	Hook clamp 40x10mm with 28mm M10 screw for Ø50 to 63mm pipes - SWL: 50Kg - Poids: 1.36 Kg	
CS2	Safety cable Ø3 mm L= 600mm - SWL: 75 Kg	