

# ROXIE - 1166C2 CW

ULTRA COMPACT - LED 300 W



- **Type:** Followspot
- **Source:** LED 300 W
- **Optics:** 10.5° to 22.5° zoom
- **Colour temperature:** Cool White
- **Standard:** 110 V North american

Followspot

## The little LED wonder with the power punch

Roxie is Robert Juliat's first LED followspot. The compact 300W spot is all about efficiency. It fits in the smallest of spaces and is the ideal energy-efficient solution for all those venues where running costs need to be significantly reduced. Roxie delivers an output comparable to most of the 575W discharge followspot available on the market. No heat, no lamp change, less maintenance. Smooth electronic dimming is available as standard, either locally via the rotary dimmer knob or remotely via DMX.

### Features

- **Fully closing iris:** removable for fast, easy replacement
- **Universal gobo holder:** "A" size glass and metal gobo
- **Local control:** light intensity adjustment through built-in potentiometer
- **Internal glass filter holder:** long term use of durable coloured, dichroic or textured glass
- **Colour changer:** 6-way, 'push/pull' colour changer system for simultaneous use of multiple filters
- **Remote setup:** all parameters can be adjusted by RDM protocol
- **Adjustable response time:** choice of fast or slow dimming for tungsten-like simulation
- **DMX:** 8 or 16 bit dimming and strobe function
- **Local setup:** DMX address and mode, dimming curve and response time through 4-button display with automatic light switch-off
- **Control:** local, DMX, wireless DMX (option)
- **Easy focus reference:** graduated scale on side of the unit; fast and easy refocusing

### Optical

- **SX optical system:** double condenser optics for exceptional optical quality
- **Coated double condenser optical system:** ensures optimal light transmission
- **Variable zoom optics:** sharp focus at every beam angle. Independent control of image size and focus.
- **Electronic dimmer:** dimming without clipping or cut-out at low intensity levels; high quality smoothing
- **No colour shift:** colour temperature remains the same when dimming

### Construction

- **Made in France :** fully manufactured in Robert Juliat premises retaining complete control over all aspects of quality
- **PSU:** built-in electronic flicker-free power supply for easy, plug-and-play installation
- **Power connectors:** compatible powerCON® TRUE1 IN and OUT connectors for daisy chaining
- **Silent-running cooling fans:** ideal for TV studios and opera houses
- **Electronic thermal management system:** ensures maximum performance of the system without any risk of overheating
- **Bodywork:** strong sheet metal construction for durability
- **Moving parts:** smooth at all times, even when hot
- **Captive knobs and handles:** additional security when working at height or in transit
- **Easy access to all parts:** easy cleaning and maintenance

Picture:1166

DSEN297\_1166C2\_CW - 03/04/2025

Robert Juliat reserves the right to change or alter any of the items detailed on this page, to increase or improve manufacturing techniques without prior notice.

Robert Juliat S.A.S., 32 rue de Beaumont, 60530 Fresnoy-en-Thelle - France  
Telephone : +33 (0)3 44 26 51 89 - info@robertjuliat.fr - www.robertjuliat.com



ROBERT JULIAT

- Lamp type: LED
- Power: 247 W

| LED specifications        | Power * | Lumen output* | Colour temperature* | Life*     | CRI* (min) |
|---------------------------|---------|---------------|---------------------|-----------|------------|
| SUHD60 V3 CW (RJ / Osram) | 247 W   | 25 725 lm     | 5700K               | 100 000 h | 92         |

(\*) manufacturer's data

## Optics

### Characteristics

- Type: Zoom
- Range: 10.5° to 22.5° (Field angle)
- Focal length: 184 - 374 mm

### Gel filter

- Shape: Circle
- Standard size: 165 mm (6.5 in)

### Gobo

- Size: A
- Material: Metal  
Glass

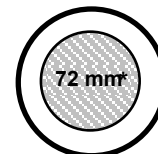

100 mm  
\*Maximum image size

## Photometrics (Photometrics report(s) available at the end of the document)

optics: 10,5°-22,5° / Standard

### • Optics @ 10.5°

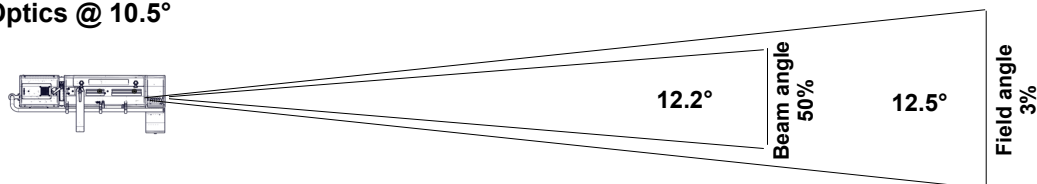

Beam intensity  
231 100 cd

Field lumens  
6 430 lm

Efficacy  
22 lm/W

|              |           |           |           |         |         |         |
|--------------|-----------|-----------|-----------|---------|---------|---------|
| Distance     | 5 m       | 10 m      | 15 m      | 20 m    | 25 m    | 30 m    |
| Diameter     | 1.1 m     | 2.2 m     | 3.3 m     | 4.4 m   | 5.5 m   | 6.6 m   |
| Illumination | 9 300 lux | 2 350 lux | 1 050 lux | 580 lux | 370 lux | 260 lux |
| Distance     | 15 ft     | 35 ft     | 50 ft     | 65 ft   | 80 ft   | 100 ft  |
| Diameter     | 3.3 ft    | 7.7 ft    | 11 ft     | 14.2 ft | 17.5 ft | 21.9 ft |
| Illumination | 1 050 fc  | 190 fc    | 95 fc     | 55 fc   | 37 fc   | 24 fc   |

### • Optics @ 22.5°

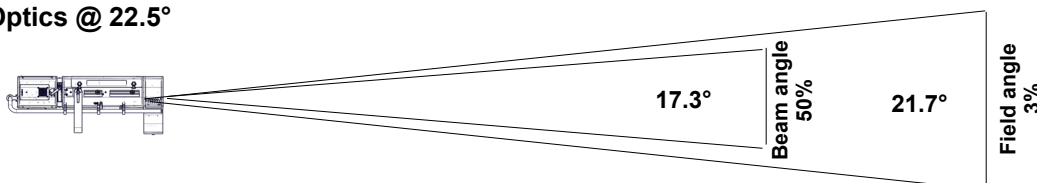

Beam intensity  
107 400 cd

Field lumens  
7 440 lm

Efficacy  
26 lm/W

|              |           |           |         |         |         |         |
|--------------|-----------|-----------|---------|---------|---------|---------|
| Distance     | 5 m       | 10 m      | 15 m    | 20 m    | 25 m    | 30 m    |
| Diameter     | 1.9 m     | 3.8 m     | 5.7 m   | 7.7 m   | 9.6 m   | 11.5 m  |
| Illumination | 4 300 lux | 1 100 lux | 480 lux | 270 lux | 180 lux | 120 lux |
| Distance     | 15 ft     | 35 ft     | 50 ft   | 65 ft   | 80 ft   | 100 ft  |
| Diameter     | 5.7 ft    | 13.4 ft   | 19.2 ft | 24.9 ft | 30.7 ft | 38.3 ft |
| Illumination | 480 fc    | 90 fc     | 43 fc   | 26 fc   | 17 fc   | 11 fc   |

## Remote control

- Data protocol: USITT DMX512-A  
RDM

- Data IN connector: 5 pins XLR male
- Data OUT connector: 5 pins XLR female

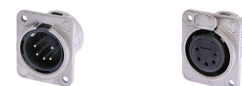

### • DMX chart:

#### Mode 1 (1 channels)

Dimmer

#### Mode 2 (4 channels)

Dimmer  
Dimmer fine  
-  
Strobe

#### Mode 3 (5 channels)

Dimmer  
Dimmer fine  
-  
Strobe  
Dimmer master

## Dimensions and weight

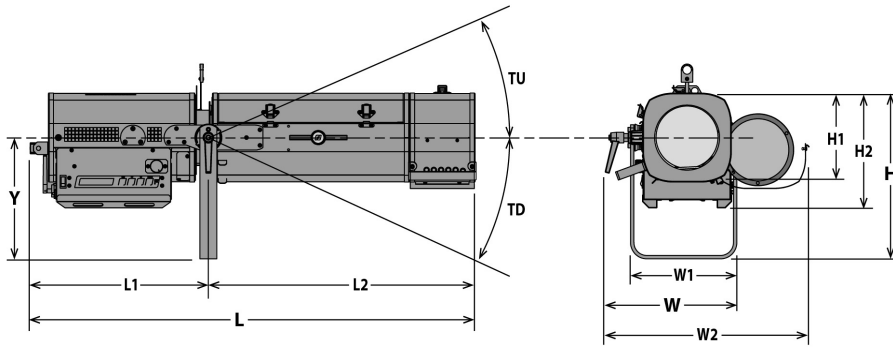

**Weight:** 20.5 kg (45.1 lbs)

| Height               | Length               | Width                | Yoke                | Tilt    |
|----------------------|----------------------|----------------------|---------------------|---------|
| H= 387 mm (15.2 in)  | L= 1045 mm (41.1 in) | W= 321 mm (12.6 in)  | Y= 283 mm (11.1 in) | TU= 51° |
| H1= 208 mm (8.2 in)  | L1= 418 mm (16.5 in) | W1= 249 mm (9.8 in)  |                     | TD= 65° |
| H2= 268 mm (10.6 in) | L2= 627 mm (24.7 in) | W2= 490 mm (19.3 in) |                     |         |

## Shipping

- **Weight :**
- **Volume :**

## Installation

- **Minimum distance to illuminated surface:** 0.6 m ( 1.8 ft )
- **Operating position:**



## Construction

- **Housing:** Steel sheet - Aluminium
- **Colour:** Black
- **Cooling:** Low noise variable fan
- **Maximum ambient temperature (Ta):** 40°C (104°F)
- **Maximum case temperature (Tc):** 70°C (158°F)
- **Total heat dissipation:** 976 BTU/h
- **Ingress Protection (IP) rating:** IP20

## Electrical compatibility

- 220/230 V - 50 Hz
- 245 V - 50 Hz
- 110/120 V - 60 Hz
- 208 V - 60 Hz
- 220/230 V - 60 Hz
- 100 V - 50 Hz
- 100 V - 60 Hz
- Selector: automatic detection

## Power input



- **Type:** removable power cord with compatible powerCON® TRUE1 connector (included)
- **Cable:** 14 AWG SJ type (UL/CSA)
- **Length:** 1.5 m (4.9 ft)
- **Power connector:** without connector

## Power consumption

| Voltage | Frequency | Current | Power | Power factor |
|---------|-----------|---------|-------|--------------|
| 230 V   | 50 Hz     | 1.3 A   | 286 W | 0.97         |
| 120 V   | 60 Hz     | 2.5 A   | 291 W | 0.99         |
| 100 V   | 60 Hz     | 3 A     | 295 W | 0.99         |

## Power Supply Unit

- **PSU:** Internal - Electronic PSU - Flicker free with PFC
- **Control:** Local / DMX
- **Protection:** Mains: 4A 1P1D breaker - UL /
- **Power thru:** compatible powerCON® TRUE1 - Maximum of 10 units (230 V) / 5 units (120 V)

## Warranty

- **Fixture: 3 years - Source: 5 years**  
See General Sales Condition on website

## Approvals



## Acoustics

- **Noise level:** < 24,9 dB(A)















## Model

|                  |  |
|------------------|--|
| <b>1166C2 CW</b> | LED 300 W Followspot - 1166C2 CW Roxie - Cool White - 10.5/22.5° - North american standard |
|------------------|--|

## Options

|               |  |   |
|---------------|--|---|
| <b>FC1124</b> | Flight-case for Ultra Compact range / GT stand - Dim: 1210x600x560mm - Weight: 35 Kg |  |
|---------------|--|---|

## Accessories

|                   |  |   |
|-------------------|--|---|
| <b>IS750</b>      | Full closing iris with holder - Weight: 0.35 Kg<br><b>1 included</b>                     |    |
| <b>PF1114</b>     | Ø165 mm metal filter holder<br><b>6 included</b>   |    |
| <b>SGUX</b>       | Universal "A" size gobo-holder (metal, glass, frosted glass)<br><b>1 included</b>        |    |
| <b>M165TP</b>     | 6 ways "push/pull" colour changer - Weight: 2.09 Kg<br><b>1 included</b>                 |    |
| <b>GT1000</b>     | Tripod stand - SWL: 40 Kg - max. height: 1550 mm - Weight: 9.27 Kg                       |   |
| <b>GT800</b>      | Tripod stand - SWL: 40 Kg - max. height: 1550 mm - Weight: 7.98 Kg                       |  |
| <b>T1000</b>      | TV spigot with followspots swivel head - Weight: 1.82 Kg                                 |  |
| <b>T4000</b>      | Followspot mount for Ø50mm pipe (suspension or overhead) - SWL= 100 Kg - Weight: 4.88 Kg |  |
| <b>CAV600A</b>    | Double slot front cassette for 180x180mm accessories - Weight: 0.43 Kg                   |  |
| <b>VD120</b>      | 120x120mm frosted glass  |  |
| <b>Kit TELRAD</b> | Telrad followspot sight with raiser and universal mounting kit - Weight: 1.23 Kg         |  |
| <b>SDUP</b>       | Followspot cue sheet holder with universal mounting kit                                  |  |
| <b>DMXcat</b>     | Bluetooth DMX/RDM Multifunction test tool - City Theatrical DMXcat®                      |  |
| <b>FC1124/S</b>   | Flight-case for Ultra Compact range / GT stand - Weight: 35 Kg                           |  |
| <b>W/GT800</b>    | Set of 3 wheels for GT800/1000 stand - Weight: 2.33 Kg                                   |  |



• Optics @ 10,5°

| Field lumens | Beam lumens | Efficacy | Beam intensity | CCT     | Delta uv |
|--------------|-------------|----------|----------------|---------|----------|
| 6 430 Lm     | 6 320 Lm    | 22 Lm/W  | 231 100 Cd     | 5 520 K |          |

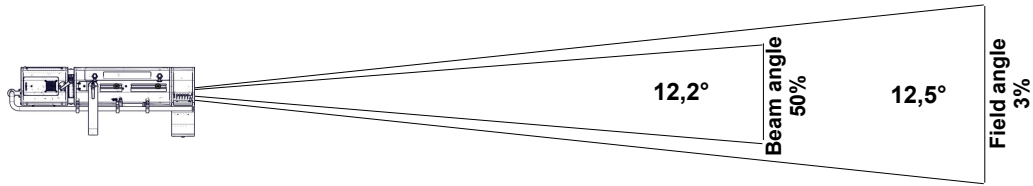

|                |           |           |           |         |         |         |
|----------------|-----------|-----------|-----------|---------|---------|---------|
| Distance       | 5 m       | 10 m      | 15 m      | 20 m    | 25 m    | 30 m    |
| Field diameter | 1,1 m     | 2,2 m     | 3,3 m     | 4,4 m   | 5,5 m   | 6,6 m   |
| Illumination   | 9 300 lux | 2 350 lux | 1 050 lux | 580 lux | 370 lux | 260 lux |
| Distance       | 15 ft     | 35 ft     | 50 ft     | 65 ft   | 80 ft   | 100 ft  |
| Field diameter | 3,3 ft    | 7,7 ft    | 11 ft     | 14,2 ft | 17,5 ft | 21,9 ft |
| Illumination   | 1 050 fc  | 190 fc    | 95 fc     | 55 fc   | 37 fc   | 24 fc   |

• Optics @ 17°

| Field lumens | Beam lumens | Efficacy | Beam intensity | CCT     | Delta uv |
|--------------|-------------|----------|----------------|---------|----------|
| 8 040 Lm     | 6 550 Lm    | 28 Lm/W  | 184 800 Cd     | 5 610 K |          |

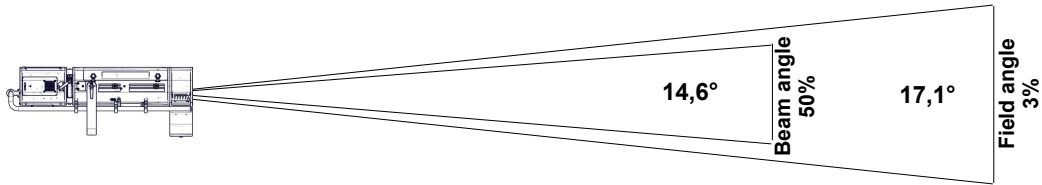

|                |           |           |         |         |         |         |
|----------------|-----------|-----------|---------|---------|---------|---------|
| Distance       | 5 m       | 10 m      | 15 m    | 20 m    | 25 m    | 30 m    |
| Field diameter | 1,5 m     | 3 m       | 4,5 m   | 6 m     | 7,5 m   | 9 m     |
| Illumination   | 7 400 lux | 1 850 lux | 830 lux | 470 lux | 300 lux | 210 lux |
| Distance       | 15 ft     | 35 ft     | 50 ft   | 65 ft   | 80 ft   | 100 ft  |
| Field diameter | 4,5 ft    | 10,5 ft   | 15 ft   | 19,5 ft | 24,1 ft | 30,1 ft |
| Illumination   | 830 fc    | 160 fc    | 75 fc   | 44 fc   | 29 fc   | 19 fc   |

• Optics @ 22,5°

| Field lumens | Beam lumens | Efficacy | Beam intensity | CCT     | Delta uv |
|--------------|-------------|----------|----------------|---------|----------|
| 7 440 Lm     | 6 220 Lm    | 26 Lm/W  | 107 400 Cd     | 5 530 K |          |

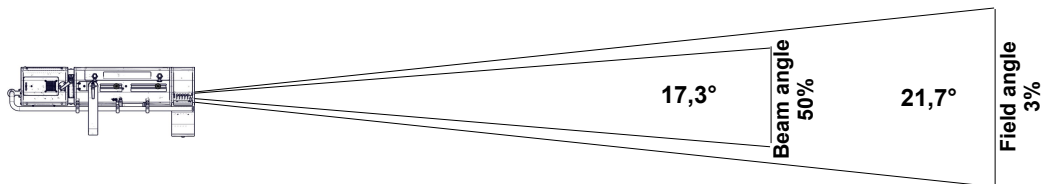

|                |           |           |         |         |         |         |
|----------------|-----------|-----------|---------|---------|---------|---------|
| Distance       | 5 m       | 10 m      | 15 m    | 20 m    | 25 m    | 30 m    |
| Field diameter | 1,9 m     | 3,8 m     | 5,7 m   | 7,7 m   | 9,6 m   | 11,5 m  |
| Illumination   | 4 300 lux | 1 100 lux | 480 lux | 270 lux | 180 lux | 120 lux |
| Distance       | 15 ft     | 35 ft     | 50 ft   | 65 ft   | 80 ft   | 100 ft  |
| Field diameter | 5,7 ft    | 13,4 ft   | 19,2 ft | 24,9 ft | 30,7 ft | 38,3 ft |
| Illumination   | 480 fc    | 90 fc     | 43 fc   | 26 fc   | 17 fc   | 11 fc   |

# Light quality report

| CCT    | DeltaUV | CRI Ra | CRI R9 | CQS Qa | TM30-18 Rf | TM30-18 Rg | TLCI |
|--------|---------|--------|--------|--------|------------|------------|------|
| 6 230K | -0.0007 | 91     | 76     | 89     | 89         | 103        | 93   |

## CRI - CIE Colour Rendering Index

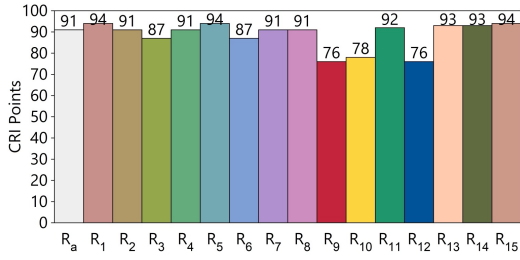

## TLCI - Television Lighting Consistency Index

Test : CCT = D6228 (-0.7)  
 TLCI-2012 : 93 (D6228)

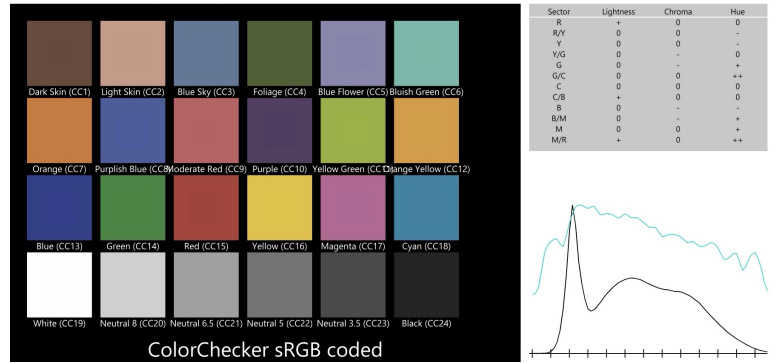

## CQS - NIST Colour Quality Scale

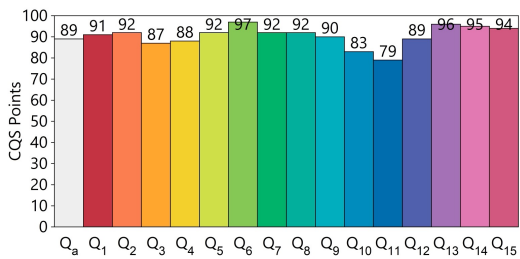

## ANSI/IES TM-30-18 Colour Rendition Report

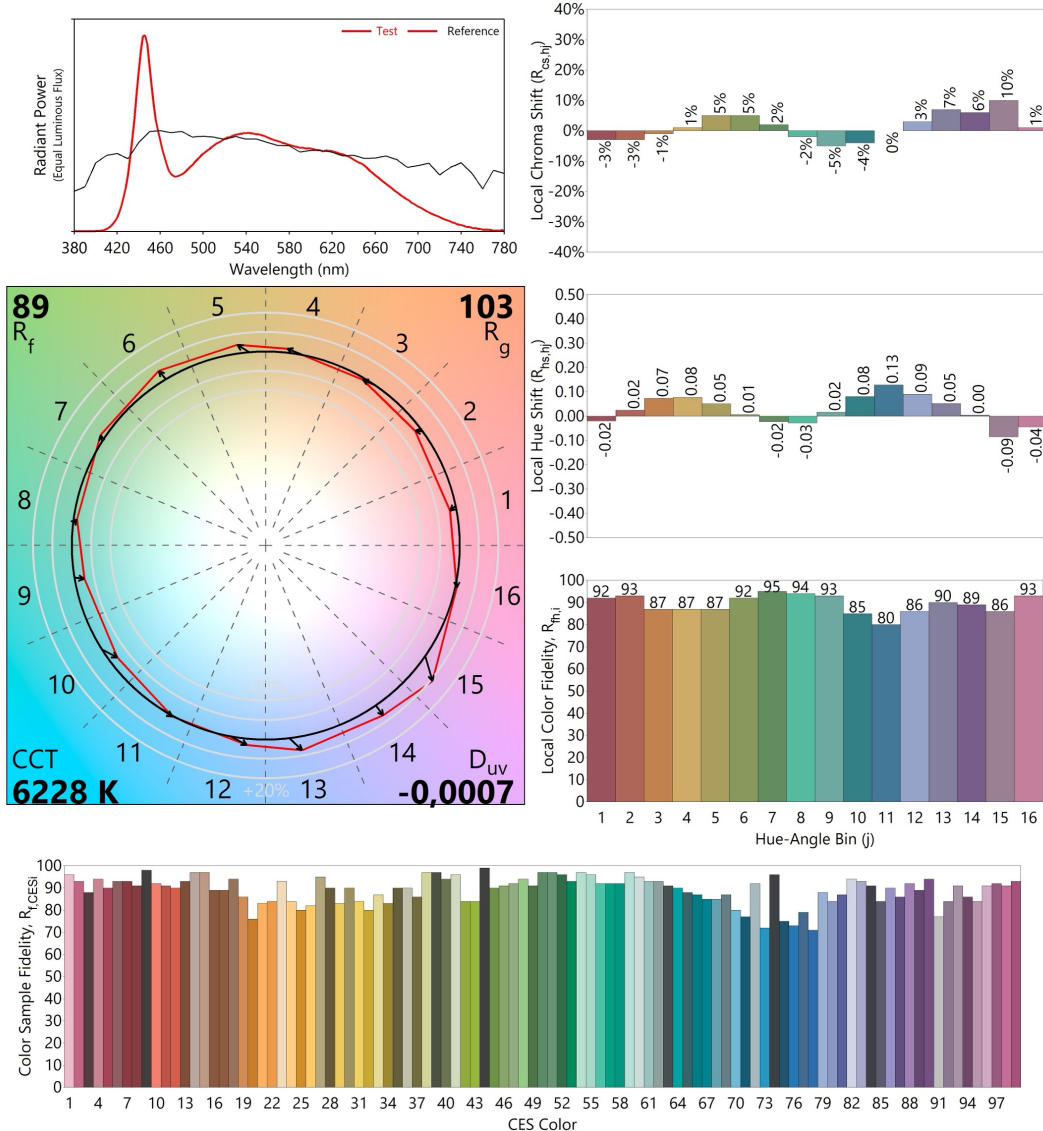

Colours are for visual orientation purposes only. Created with the IES TM-30-18 Calculator Version 2.00