

TIBO - 535CVW

500 - LED 30 W - VARIABLE WHITE



- **Type:** Single lens luminaire
- **Source:** LED 30 W - Variable White
- **Optics:** 130 mm Fresnel lens
- **Colour temperature:** 2700K --> 5700K
- **Standard:** 110 V North american

Single lens

The new Fresnel generation

The ideal tool for wash light, back and side lighting. Tibo LED Fresnel is an innovative, energy efficient lighting tool featuring an excellent optical system. Cool or warm white washes can be achieved in one single unit without the need for colour correction filters and the reduced light output these cause. All Tibo LED units have a flicker-free ballast which makes them suitable for film, television and studio environments as well as in conventional theatre. The variable white version offers a finely-tuned control of colour temperatures.

Features

- **Continuous 360° rotation of the fixture:** adjustment of the projected image is always possible
- **Theatre front cassette:** no light spill to distract audiences or performers
- **Colour runners:** double runners to hold accessories and colour filters
- **Barn door:** unique barn door with 4 individually rotating blades – makes even the most difficult angle possible
- **Parameters:** adjustable curves and response thru 4-button display with automatic light switch-off
- **DMX:** 8 or 16 bits dimming, CCT and strobe function
- **Control:** local and DMX
- **Smooth focus adjustment:** from top and bottom with a user-friendly system
- **Tilt reference on hanging yoke:** index for rapid re-positioning

Optical

- **Very long-life lamp source:** 50 000 hours - Lumen maintenance greater than 70% after 50 000 hours
- **Colour correction:** possibility to adjust the colour temperature from 2700K to 5700K
- **Beam range:** fresnel lens and light source are fixed. Beam angle made by moveable lens.
- **Wash effect:** soft edges, very even beam
- **Very wide beam spread:** up to 85° from edge to edge
- **Electronic dimmer:** dimming without clipping or cut-out at low intensity levels; high quality smoothing
- **No colour shift:** colour temperature remains the same when dimming

Construction

- **Made in France :** fully manufactured in Robert Juliat premises retaining complete control over all aspects of quality
- **Power connectors:** neutriK® powerCON TRUE1 IN and OUT connectors for daisy chaining
- **Separate electronic flicker-free PSU:** can be separate or on yoke
- **Silent-running cooling fans:** ideal for TV studios and opera houses
- **Electronic thermal management system:** ensures maximum performance of the system without any risk of overheating
- **Bodywork:** die cast aluminium housing
- **Captive knobs and handles:** additional security when working at height or in transit
- **Spare parts and accessories:** uniform across the tungsten, LED or HID TIBO range, reducing running costs
- **Safety first:** front accessories safety cable attachment point
- **Aesthetic impact:** no safety grid

Picture:535 + CF100

DSEN207_535CVW - 28/03/2019

Robert Juliat reserves the right to change or alter any of the items detailed on this page, to increase or improve manufacturing techniques without prior notice.

Robert Juliat S.A.S., 32 rue de Beaumont, 60530 Fresnoy-en-Thelle - France
Telephone : +33 (0)3 44 26 51 89 - fax : +33 (0)3 44 26 90 79 - info@robertjuliat.fr
www.robertjuliat.com



ROBERT JULIAT

Source



- Lamp type: LED
- Power: 30 W

LED specifications	Power *	Lumen output*	Colour temperature*	Life*	CRI* (min)
Tibo 30W VW (Robert Juliat)	30 W	2 000 lm	2700K --> 5700K	50 000 h	92

(*) manufacturer's data

Optics

Characteristics

- Type: Single lens
- Beam range: 54° to 85°
- Lens: 130 mm Fresnel lens

Gel filter

- Shape: Square
- Standard size: 138x138 mm (5.4x5.4 in)

Photometrics

with CDM-T 250W 942 (Philips) source

• Optics @ 54°

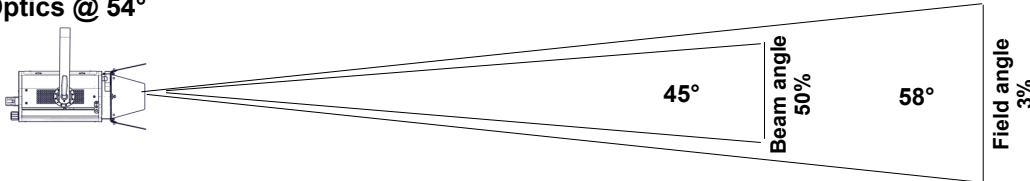

Beam intensity
4 100 cd

Distance	1 m	3 m	5 m	8 m	10 m	13 m
Diameter	1.1 m	3.3 m	5.5 m	8.9 m	11.1 m	14.4 m
Illumination	4 150 lux	460 lux	170 lux	65 lux	42 lux	25 lux
Distance	10 ft	10 ft	15 ft	25 ft	35 ft	45 ft
Diameter	11.1 ft	11.1 ft	16.6 ft	27.7 ft	38.8 ft	49.9 ft
Illumination	42 fc	42 fc	19 fc	7 fc	4 fc	3 fc

CCT
3 580 K

• Optics @ 85°

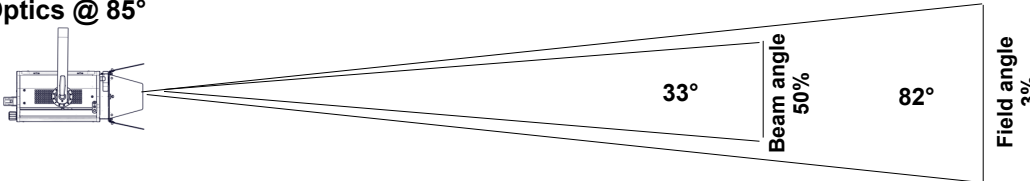

Beam intensity
6 600 cd

Distance	1 m	3 m	5 m	8 m	10 m	13 m
Diameter	1.7 m	5.2 m	8.7 m	13.9 m	17.4 m	22.6 m
Illumination	6 700 lux	740 lux	270 lux	110 lux	70 lux	40 lux
Distance	10 ft	10 ft	15 ft	25 ft	35 ft	45 ft
Diameter	17.4 ft	17.4 ft	26.1 ft	43.5 ft	60.9 ft	78.2 ft
Illumination	70 fc	70 fc	30 fc	11 fc	6 fc	4 fc

CCT
3 830 K

Remote control

- Data protocol: USITT DMX512-A
RDM / Art-Net / sACN

- Data IN connector: 5 pins XLR male
- Data OUT connector 5 pins XLR female



• DMX chart:

Mode 1 (1 channels)	Mode 2 (4 channels)	Mode 3 (5 channels)	Mode 4 (5 channels)
Dimmer	Dimmer Dimmer fine CCT Strobe	Dimmer Dimmer fine CCT Strobe Dimmer master	Warm White Warm White fine Cool White Cool White fine Strobe

Dimensions and weight

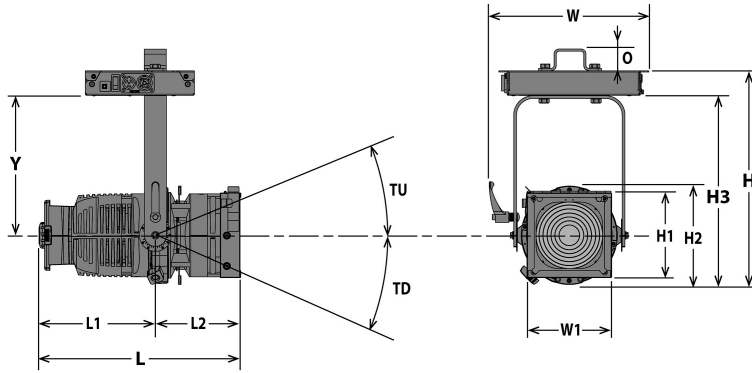

Weight: 8.5 kg (18.7 lbs)

with PSU

Height	Length	Width	Yoke	Tilt	Option
H= 385 mm (15.2 in)	L= 355 mm (14 in)	W= 288 mm (11.3 in)	Y= 252 mm (9.9 in)	TU= 90°	O= 30 mm (1,2 in)
H1= 156 mm (6.1 in)	L1= 200 mm (7.9 in)	W1= 162 mm (6.4 in)		TD= 90°	
H2= 174 mm (6.9 in)	L2= 155 mm (6.1 in)	W2= 251 mm (9.9 in)			
H3= 340 mm (13.4 in)					

Shipping

• **Weight :** 10 kg (22 lbs)

• **Volume :** .04 m³ (1.41 ft³)

PSU

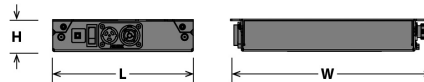

Width: W= 271 mm (10.7 in)

Height: H= 44 mm (1.7 in)

Length: L= 195 mm (7.7 in)

Weight: 2.4 Kg (5.3 lbs)

Installation

• **Minimum distance to illuminated surface:** 0.3 m (1.0 ft)

• **Operating position:**

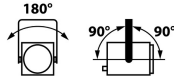

Warranty

• **Period: 2 years**
See General Sales Condition on website

Approvals



Construction

- **Housing:** Die cast aluminium
- **Colour:** Black
- **Cooling:** Low noise variable fan
- **Maximum ambient temperature (Ta):** 40°C (104°F)
- **Maximum case temperature (Tc):** 60°C (140°F)
- **Total heat dissipation:** 123 BTU/h
- **Protection rating:** 20

- **PSU housing:** Steel sheet - Aluminium
- **PSU colour:** Black
- **PSU cooling:** Convection cooling
- **PSU maximum ambient temperature (Ta):** 40°C (104°F)
- **PSU maximum case temperature (Tc):** 50°C (122°F)

Electrical compatibility

- 220/230 V - 50 Hz
- 245 V - 50 Hz
- 110/120 V - 60 Hz
- 208 V - 60 Hz
- 220/230 V - 60 Hz
- 100 V - 50 Hz
- 100 V - 60 Hz
- Selector: automatic detection

Power input



- **Type:** removeable power cord with Neutrik powerCON TRUE1 connector (included)
- **Cable:** 14 AWG SJ type (UL/CSA)
- **Length:** 1,5 m (4,9 ft)
- **Power connector:** without connector

Power consumption

Voltage	Frequency	Current	Power	Power factor
230 V	50 Hz	0.17 A	36 W	>0.84
120 V	60 Hz	0.3 A	36 W	
100 V	60 Hz	0.36 A	36 W	

Power Supply Unit



- **PSU:** On yoke - Electronic PSU - Flicker free with PFC
- **Lighting unit / PSU cable:** Cable attached to unit - length: 1,5 m (4,9 ft)
Type: 3M ref. 3696 with 12 pins M16 locking connector
- **Maximum distance between lighting unit and PSU:** 5 m (16 ft)
- **Control:** Local / DMX
- **Protection:** Mains: 4A 1P1D breaker - UL /
- **Power thru:** Neutrik powerCON TRUE1 - Maximum of 35 units (230 V) / 20 units (120 V)



Model

535CVW	LED 30 W - Variable White Single lens luminaire - 130mm Fresnel - 535CVW Tibo - North american standard
---------------	---------------------------------------------------------------------------------------------------------

Options

T-RAL9010	White housing (RAL 9010)	
------------------	--------------------------	-------------------------------------------------------------------------------------

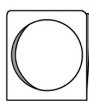
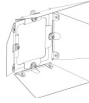
Accessories

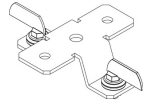
PF100M	135x135mm metal filter holder 1 included	
EXT/TiboVW	12 pins Tibo LED variable white extension cable - length = 3.m (138")	
CF100	4 rotating leaves on a barndoor - 135x135mm (without safety cable) - Weight: ,71 Kg	
872	Doughty "Twenty clamp" with M10 screw/nut for Ø48 to 51mm pipes - SWL: 20Kg - TÜV approved - Weight: ,25 Kg	
878	Hook clamp 25x6mm with 23mm M10 screw for Ø35 to 50mm pipes - SWL: 11Kg - Weight: ,46 Kg	
OmegaT2	Omega bracket with quarter turn bolt sets for PSU - Weight: ,42 Kg	
CS2	Safety cable Ø3 mm L= 600mm - SWL: 75 Kg	