

TIBO - 535CNW

500 - LED 75 W



- **Type:** Single lens luminaire
- **Source:** LED 75 W
- **Optics:** 130 mm Fresnel lens
- **Colour temperature:** Neutral White
- **Standard:** 110 V North american

Single lens

The new Fresnel generation

The ideal tool for wash light, back and side lighting. Tibo LED Fresnel is an innovative, energy efficient lighting tool featuring an excellent optical system. All Tibo LED units have a flicker-free ballast which makes them suitable for film, television and studio environments as well as in conventional theatre.

Features

- **Continuous 360° rotation of the fixture:** adjustment of the projected image is always possible
- **Theatre front cassette:** no light spill to distract audiences or performers
- **Colour runners:** double runners to hold accessories and colour filters
- **Barn door:** unique barn door with 4 individually rotating blades – makes even the most difficult angle possible
- **DMX:** 8 or 16 bits dimming and strobe function
- **Parameters:** adjustable curves and response thru 4-button display with automatic light switch-off
- **Control:** local, DMX, wireless DMX (option)
- **Smooth focus adjustment:** from top and bottom with a user-friendly system
- **Tilt reference on hanging yoke:** index for rapid re-positioning

Optical

- **Very long-life lamp source:** 50 000 hours - Lumen maintenance greater than 70% after 50 000 hours
- **Beam range:** fresnel lens and light source are fixed. Beam angle made by moveable lens.
- **Wash effect:** soft edges, very even beam
- **Very wide beam spread:** up to 85° from edge to edge
- **Electronic dimmer:** dimming without clipping or cut-out at low intensity levels; high quality smoothing
- **No colour shift:** colour temperature remains the same when dimming

Construction

- **Made in France :** fully manufactured in Robert Juliat premises retaining complete control over all aspects of quality
- **Power connectors:** neutriK® powerCON TRUE1 IN and OUT connectors for daisy chaining
- **Separate electronic flicker-free PSU:** can be separate or on yoke
- **Silent-running cooling fans:** ideal for TV studios and opera houses
- **Electronic thermal management system:** ensures maximum performance of the system without any risk of overheating
- **Bodywork:** die cast aluminium housing
- **Captive knobs and handles:** additional security when working at height or in transit
- **Spare parts and accessories:** uniform across the tungsten, LED or HID TIBO range, reducing running costs
- **Safety first:** front accessories safety cable attachment point
- **Aesthetic impact:** no safety grid

Picture:535 + CF100

DSEN202_535CNW - 07/01/2020

Robert Juliat reserves the right to change or alter any of the items detailed on this page, to increase or improve manufacturing techniques without prior notice.

Robert Juliat S.A.S., 32 rue de Beaumont, 60530 Fresnoy-en-Thelle - France
Telephone : +33 (0)3 44 26 51 89 - fax : +33 (0)3 44 26 90 79 - info@robertjuliat.fr
www.robertjuliat.com



ROBERT JULIAT

Source



- Lamp type: LED
- Power: 75 W

LED specifications	Power *	Lumen output*	Colour temperature*	Life*	CRI* (min)
Tibo 75W NW (Robert Juliat)	75 W	5 800 lm	4000K	50 000 h	82

(*) manufacturer's data

Optics

Characteristics

- Type: Single lens
- Beam range: 54° to 85°
- Lens: 130 mm Fresnel lens

Gel filter

- Shape: Square
- Standard size: 138x138 mm (5.4x5.4 in)

Photometrics

with Tibo 75W NW (Robert Juliat) source

• Optics @ 54°

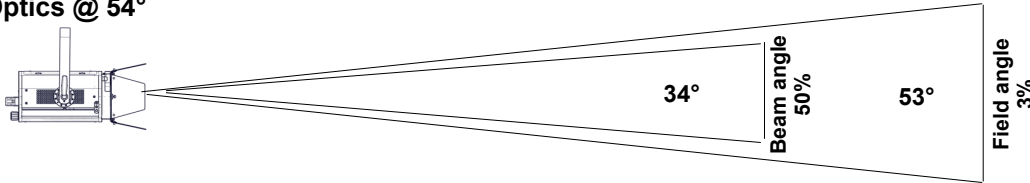

Beam intensity
2 160 cd

Distance	1 m	2 m	3 m	4 m	5 m	6 m
Diameter	1 m	2 m	3 m	4 m	5 m	6 m
Illumination	2 200 lux	550 lux	250 lux	140 lux	90 lux	65 lux
Distance	10 ft	5 ft	10 ft	15 ft	15 ft	20 ft
Diameter	10 ft	5 ft	10 ft	15 ft	15 ft	19.9 ft
Illumination	22 fc	90 fc	22 fc	10 fc	10 fc	6 fc

CCT
4 080 K

CRI
83

• Optics @ 85°

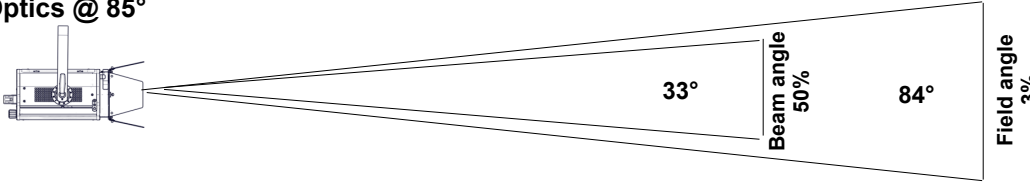

Beam intensity
1 000 cd

Distance	1 m	2 m	3 m	4 m	5 m	6 m
Diameter	1.8 m	3.6 m	5.4 m	7.2 m	9 m	10.8 m
Illumination	1 010 lux	260 lux	120 lux	65 lux	41 lux	28 lux
Distance	10 ft	5 ft	10 ft	15 ft	15 ft	20 ft
Diameter	18 ft	9 ft	18 ft	27 ft	27 ft	36 ft
Illumination	11 fc	41 fc	11 fc	5 fc	5 fc	3 fc

CCT
4 110 K

CRI
83

Remote control

- Data protocol: USITT DMX512-A
RDM

- Data IN connector: 5 pins XLR male
- Data OUT connector: 5 pins XLR female



• DMX chart:

Mode 1 (1 channels)

Dimmer

Mode 2 (4 channels)

Dimmer
Dimmer fine
-
Strobe

Mode 3 (5 channels)

Dimmer
Dimmer fine
-
Strobe
Dimmer master

Dimensions and weight

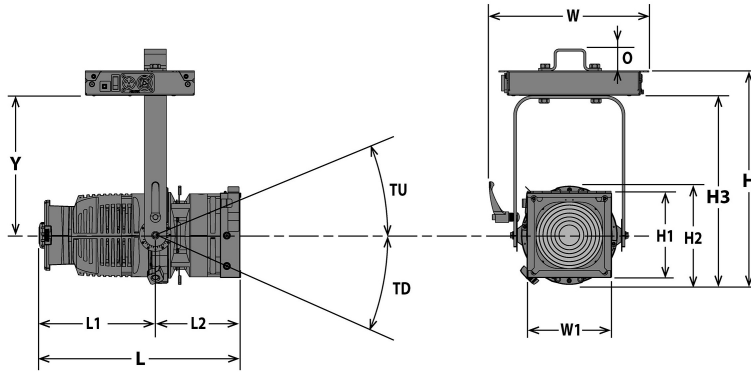

Weight: 8.3 kg (18.3 lbs)
with PSU

Height	Length	Width	Yoke	Tilt	Option
H= 385 mm (15.2 in)	L= 355 mm (14 in)	W= 288 mm (11.3 in)	Y= 252 mm (9.9 in)	TU= 90°	O= 30 mm (1,2 in)
H1= 156 mm (6.1 in)	L1= 200 mm (7.9 in)	W1= 162 mm (6.4 in)		TD= 90°	
H2= 174 mm (6.9 in)	L2= 155 mm (6.1 in)	W2= 251 mm (9.9 in)			
H3= 340 mm (13.4 in)					

Shipping

• **Weight :** 9.8 kg (21.6 lbs)

• **Volume :** .04 m³ (1.41 ft³)

PSU

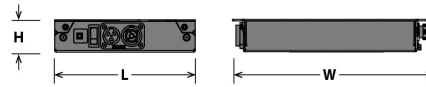

Width: W= 271 mm (10.7 in)

Height: H= 44 mm (1.7 in)

Length: L= 195 mm (7.7 in)

Weight: 2.2 Kg (4.8 lbs)

Installation

• **Minimum distance to illuminated surface:** 0.3 m (1.0 ft)

• **Operating position:**

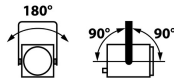

Warranty

• **Fixture: 3 years - Source: 5 years**
See General Sales Condition on website

Approvals



Construction

- **Housing:** Die cast aluminium
- **Colour:** Black
- **Cooling:** Low noise variable fan
- **Maximum ambient temperature (Ta):** 40°C (104°F)
- **Maximum case temperature (Tc):** 60°C (140°F)
- **Total heat dissipation:** 324 BTU/h
- **Protection rating:** 20

- **PSU housing:** Steel sheet - Aluminium
- **PSU colour:** Black
- **PSU cooling:** Convection cooling
- **PSU maximum ambient temperature (Ta):** 40°C (104°F)
- **PSU maximum case temperature (Tc):** 50°C (122°F)

Electrical compatibility

- 220/230 V - 50 Hz
- 245 V - 50 Hz
- 110/120 V - 60 Hz
- 208 V - 60 Hz
- 220/230 V - 60 Hz
- 100 V - 50 Hz
- 100 V - 60 Hz
- Selector: automatic detection

Power input



- **Type:** removeable power cord with Neutrik powerCON TRUE1 connector (included)
- **Cable:** 14 AWG SJ type (UL/CSA)
- **Length:** 1,5 m (4,9 ft)
- **Power connector:** without connector

Power consumption

Voltage	Frequency	Current	Power	Power factor
230 V	50 Hz	0.42 A	95 W	>0.98
120 V	60 Hz	0.8 A	95 W	>0.98
100 V	60 Hz	0.95 A	95 W	>0.94

Power Supply Unit



- **PSU:** On yoke - Electronic PSU - Flicker free with PFC
- **Lighting unit / PSU cable:** Cable attached to unit - length: 1,5 m (4,9 ft)
Type: 3M ref. 3696 with 12 pins M16 locking connector
- **Maximum distance between lighting unit and PSU:** 5 m (16 ft)
- **Control:** Local / DMX
- **Protection:** Mains: 4A 1P1D breaker - UL /
- **Power thru:** Neutrik powerCON TRUE1 - Maximum of 35 units (230 V) / 20 units (120 V)



Model

535CNW	LED 75 W Single lens luminaire - 130mm Fresnel - 535CNW Tibo - Neutral White - North american standard
---------------	--

Options

T-RAL9010	White housing (RAL 9010)	
W-DMX/T	W-DMX wireless DMX	

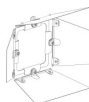
Accessories

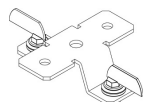
PF100M	135x135mm metal filter holder 1 included	
EXT/TiboFW	12 pins Tibo LED white extension cable - length = 3.5m (138")	
CF100	4 rotating leaves on a barndoor - 135x135mm (without safety cable) - Weight: ,71 Kg	
872	Doughty "Twenty clamp" with M10 screw/nut for Ø48 to 51mm pipes - SWL: 20Kg - TÜV approved - Weight: ,25 Kg	
878	Hook clamp 25x6mm with 23mm M10 screw for Ø35 to 50mm pipes - SWL: 11Kg - Weight: ,46 Kg	
OmegaT2	Omega bracket with quarter turn bolt sets for PSU - Weight: ,42 Kg	
CS2	Safety cable Ø3 mm L= 600mm - SWL: 75 Kg	