

# FLO - 1459CB

COMPACT - 1800 W MSR



- **Type:** Followspot
- **Source:** 1800 W MSR
- **PSU:** Electronic - hot restrike - DMX
- **Optics:** 13° to 24° zoom
- **DMX-control of motorised dimmer shutter and lamp ignition**
- **Standard:** 208 V North american

Followspot

## Small enough for a truss spot, big enough to impress

With a combination of compact dimensions, high output to rival 2500 W followspots, hot restrike lamp, electronic PSU and DMX-control, Flo is perfect for rental companies. It has become the new benchmark followspot for large theatres, TV studios, fashion shows, concerts and touring.

### Features

- **Fully closing iris cassette:** removable for fast, easy replacement; protective backplate for extended lifespan
- **Universal adjustable gobo holder:** "A" size glass and metal gobos
- **Ergonomic dimmer control:** one-handed dim, pan and tilt
- **Smooth dimmer shutter:** retains flat beam and colour temperature when dimming
- **Remote DMX-control:** DMX-control of motorised dimmer shutter - effects synchronising remotely with pinpoint accuracy. Control from both local and DMX through 'Master' function
- **Frost filter:** on flip lever for quick soft-edge beam effect
- **Horizontal chopper (optional):** for masking control in TV studios and wide stages
- **Internal glass filter holder:** long term use of durable coloured, dichroic or textured glass
- **Individually removable colour frame:** gels replaced easily while colour cassette remains in place
- **Colour changer:** 6-way, 'push/pull' colour changer system for simultaneous use of multiple filters
- **Scroller:** standard scroller colour changer can be installed and powered from the unit through built-in XLR (24V+DMX) output connector
- **RJ NET:** ensures optimum operation capacities, providing a wide pallet of feedback information (dimming level, lamp hours, projector status...) on integrated LCD display
- **DMX remote controlled ignition**
- **Easy focus reference:** graduated scale on side of the unit; fast and easy refocusing
- **Adjustable yoke (optional):** for optimum overhead positioning
- **Fine balance:** precision positioning and smooth operation even with the smallest movements
- **Stand:** perfectly weighted for maximum stability with smooth rotation for optimum performance. Easy set up; triple safety system for extra security

### Optical

- **Factory set optical train:** travels safely within followspot and requires no time-consuming realignment on arrival. Uniform beam on all followspots of same type
- **SX optical system:** double condenser optics for exceptional optical quality
- **Gobo :** excellent gobo projection
- **Variable zoom optics:** sharp focus at every beam angle. Independent control of image size and focus.

### Construction

- **Made in France :** fully manufactured in Robert Juliat premises retaining complete control over all aspects of quality
- **Separate PSU:** compact for easy handling and rapid maintenance
- **Bodywork:** strong sheet metal construction for durability
- **Ergonomic wrap-around handle:** comfort, safety and practicality from all operating positions
- **Moving parts:** smooth at all times, even when hot
- **Captive knobs and handles:** additional security when working at height or in transit
- **Easy access to all parts:** easy cleaning, re-lamping and maintenance
- **Removable assemblies:** fast-plug cable connectors and complete component assemblies (mirror, condenser set and lamp house assembly) save maintenance and cleaning time
- **Safety:** safety switch for secure access to the lamp

Picture: 1459 + FRO/1117PV

DSEN121\_1459CB - 03/04/2025

Robert Juliat reserves the right to change or alter any of the items detailed on this page, to increase or improve manufacturing techniques without prior notice.

Robert Juliat S.A.S., 32 rue de Beaumont, 60530 Fresnoy-en-Thelle - France  
Telephone : +33 (0)3 44 26 51 89 - info@robertjuliat.fr - www.robertjuliat.com



ROBERT JULIAT

## Source



- **Lamp type:** Discharge
- **Power:** 1800 W
- **Socket:** SFC 15.5-6
- **Hot re-strike:** yes

Admissible lamps	Power *	Lumen output*	Colour temperature*	Life*	CRI* (min)
MSR 1800W DE (Philips)	1 800 W	145 000 lm	6000K	750 h	85
KHD 1800W HR/DE (KLS)	1 800 W	155 000 lm	6000K	750 h	90

(\*) manufacturer's data

## Optics

### Characteristics

- **Type:** Zoom
- **Range:** 13° to 24° (Field angle)
- **Focal length:** 169 - 316 mm

### Gel filter

- **Shape:** Circle
- **Standard size:** 210 mm (8.3 in)

### Gobo

- **Size:** A
- **Material:** Metal  
Glass



## Photometrics

optics: 13°-24° / Standard / MSR 1800W DE (Philips)

### • Optics @ 13°

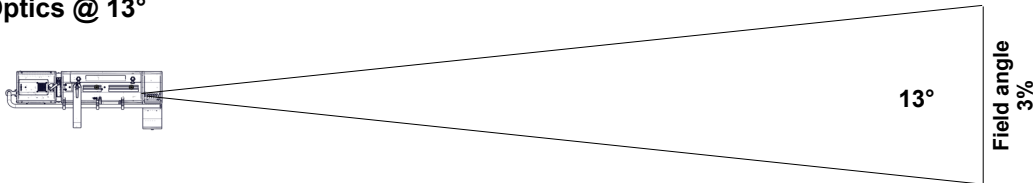

**Beam intensity**  
800 000 cd

<b>Distance</b>	10 m	15 m	20 m	25 m	30 m	35 m
<b>Diameter</b>	2.3 m	3.4 m	4.6 m	5.7 m	6.8 m	8 m
<b>Illumination</b>	8 100 lux	3 600 lux	2 050 lux	1 300 lux	890 lux	660 lux
<b>Distance</b>	35 ft	50 ft	65 ft	80 ft	100 ft	115 ft
<b>Diameter</b>	8 ft	11.4 ft	14.8 ft	18.2 ft	22.8 ft	26.2 ft
<b>Illumination</b>	660 fc	330 fc	190 fc	130 fc	85 fc	65 fc

### • Optics @ 24°

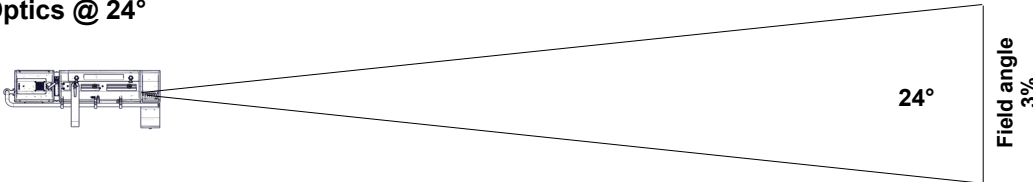

**Beam intensity**  
300 000 cd

<b>Distance</b>	10 m	15 m	20 m	25 m	30 m	35 m
<b>Diameter</b>	4.3 m	6.4 m	8.5 m	10.6 m	12.8 m	14.9 m
<b>Illumination</b>	3 050 lux	1 350 lux	760 lux	490 lux	340 lux	250 lux
<b>Distance</b>	35 ft	50 ft	65 ft	80 ft	100 ft	115 ft
<b>Diameter</b>	14.9 ft	21.3 ft	27.6 ft	34 ft	42.5 ft	48.9 ft
<b>Illumination</b>	250 fc	130 fc	75 fc	47 fc	31 fc	23 fc

## Remote control

• **Data protocol:** USITT DMX512-A

- **Data IN connector:** 5 pins XLR male
- **Data OUT connector:** 5 pins XLR female

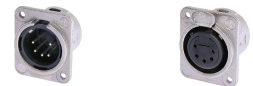

### • DMX chart:

#### Mode 1 (2 channels)

Mode control  
Dimmer

#### Mode 2 (3 channels)

Mode control  
Dimmer  
Dimmer fine

#### Mode 3 (3 channels)

Mode control  
Dimmer  
Dimmer master

#### Mode 4 (4 channels)

Mode control  
Dimmer  
Dimmer fine  
Dimmer master

## Dimensions and weight

### Unit

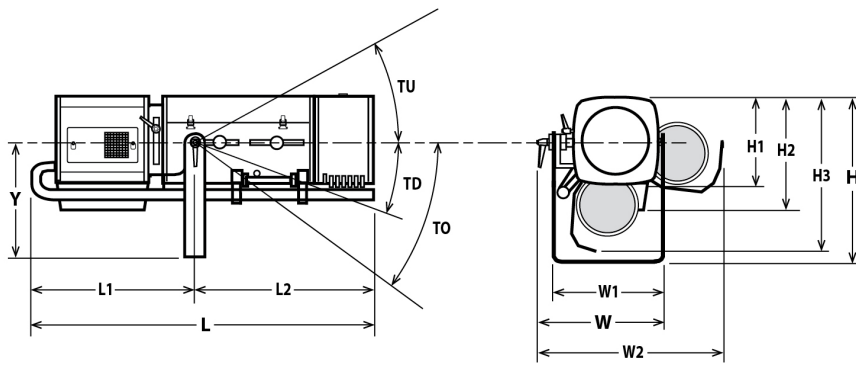

**Weight:** 35 kg (77 lbs)

Height	Length	Width	Yoke	Tilt	Option
H= 450 mm (17.7 in)	L= 970 mm (38.2 in)	W= 410 mm (16.1 in)	Y= 325 mm (12.8 in)	TU= 45°	TO= TBD°
H1= 250 mm (9.8 in)	L1= 480 mm (18.9 in)	W1= 350 mm (13.8 in)		TD= 40°	
H2= 340 mm (13.4 in)	L2= 490 mm (19.3 in)	W2= 570 mm (22.4 in)			
H3= 490 mm (19.3 in)					

### Shipping

• **Weight :** 82 kg (180.4 lbs)

• **Volume :** .58 m<sup>3</sup> (20.48 ft<sup>3</sup>)

### PSU

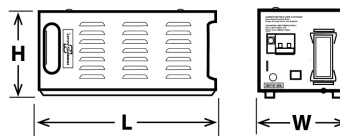

**Width:** W= 185 mm (7.3 in)  
**Height:** H= 200 mm (7.9 in)  
**Length:** L= 590 mm (23.2 in)  
**Weight:** 13.2 Kg (29 lbs)

### Installation

• **Minimum distance to illuminated surface:** 3.5 m (11.5 ft)

• **Operating position:**

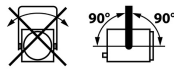

### Warranty

• **Fixture: 2 years**  
 See General Sales Condition on website

### Approvals



### Construction

- **Housing:** Steel sheet - Aluminium
- **Colour:** Black
- **Cooling:** Low noise fan
- **Maximum ambient temperature (Ta):** 40°C (104°F)
- **Maximum case temperature (Tc):** 230°C (446°F)
- **Total heat dissipation:** 6 963 BTU/h
- **Ingress Protection (IP) rating:** IP20

- **PSU housing:** Steel sheet - Aluminium
- **PSU colour:** Black
- **PSU cooling:** Fans
- **PSU maximum ambient temperature (Ta):** 40°C (104°F)
- **PSU maximum case temperature (Tc):** 50°C (122°F)

### Electrical compatibility

- 220/230 V - 50 Hz
- 245 V - 50 Hz
- ~~110/120 V - 60 Hz~~
- 208 V - 60 Hz
- 220/230 V - 60 Hz
- ~~100 V - 50 Hz~~
- ~~100 V - 60 Hz~~
- Selector: automatic detection

### Power input



- **Type:** removable power cord with Neutrik PowerCon® (ref. NAC3FCA) connector (included)
- **Cable:** 14 AWG SJ type (UL/CSA)
- **Length:** 1.5 m (4.9 ft)
- **Power connector:** without connector

### Power consumption

Voltage	Frequency	Current	Power	Power factor
230 V	50 Hz	8.9 A	2040 W	0.98
208 V	60 Hz	?	2040 W	0.97
245 V	50 Hz			

### Power Supply Unit

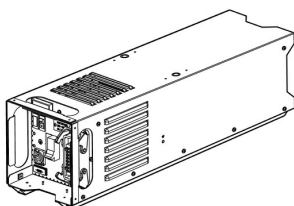





- **PSU:** Separate - Electronic PSU - Flicker free with PFC
- **Lighting unit / PSU cable:** Removable cable - length: 3 m (9,8 ft)  
 Type: 18G1,5 JZ 602-RC (CE-UL/CSA) with 16x16A+E Harting Han® connectors
- **Maximum distance between lighting unit and PSU:** 25 m (82 ft)
- **Control:** Local / DMX
- **Protection:** Mains: 15A 2P2D - C curve breaker - UL / Electronic: 2A 5x20 T fuse









## Model

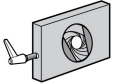





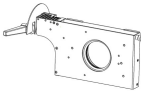









<b>1459CB</b>	1800 W MSR Followspot - 1459CB Flo - 13/24° - Electronic PSU - DMX dimmer and lamp control - 208V North american standard
---------------	---



## Options

<b>FRO/1117PV</b>	Heavy duty adjustable yoke	
<b>FRO/SMEPV</b>	Heavy duty adjustable yoke equipped with TILT SpotMe sensor (E type)	
<b>PG80</b>	Ø80mm chopper kit (G80+ GR120+ adaptation kit)	
<b>CAG/C</b>	Left side controls option for Compact range (Iris/Dimmer/Frost/Colour changer)	
<b>FC1459</b>	Flight-case for Compact range / GT stand / P.S.U. / accessories - Dim: 1340x710x700mm - Weight: 55 Kg	

## Accessories

<b>KHD 1800W HR/DE</b>	KHD 1800W HR/DE - KLS SFc 15.5-6 1800W 750h 6000K lamp <b>1 included</b>	
<b>CCU1</b>	Full closing iris cassette - Ø72mm - Weight: 1.33 Kg <b>1 included</b>	
<b>PF1011</b>	Ø210 mm metal filter holder <b>6 included</b>	
<b>SGUP2</b>	Universal "A" size gobo-holder (metal, glass, frosted glass) <b>1 included</b>	
<b>FACM100</b>	Ø97mm UV/IR filter with holder <b>1 included</b>	
<b>VDM100</b>	Ø97mm frosted glass with holder <b>1 included</b>	
<b>M210TV</b>	6 ways "push/pull" colour changer with fan <b>1 included</b>	
<b>TC1149</b>	Tool case with spare parts - Weight: 1.65 Kg <b>1 included</b>	
<b>CCU1SM</b>	Full closing iris cassette with position sensor for SpotMe system - Ø72mm	
<b>GT1000</b>	Tripod stand - SWL: 40 Kg - max. height: 1550 mm - Weight: 9.27 Kg	
<b>GT4000</b>	Tripod stand with safety chain - SWL: 130 Kg - max. height: 1030 mm - Weight: 7.91 Kg	

<b>GT4000RSM</b>	Tripod stand with ball head rotation with security chain and SpotMe PAN sensor - SWL: 130 Kg - max. height: 1030 mm	
<b>GT4000S</b>	Tripod stand without safety chain - SWL: 130 Kg - max. height: 1030 mm - Weight: 8.65 Kg	
<b>JPP</b>	Monopod stand for overhead followspot - Weight: 3.6 Kg	
<b>T1000</b>	TV spigot with followspots swivel head - Weight: 1.82 Kg	
<b>T4000</b>	Followspot mount for Ø50mm pipe (suspension or overhead) - SWL= 100 Kg - Weight: 4.88 Kg	
<b>T4000RSM</b>	Followspot mount with ball head rotation and SpotMe PAN sensor - SWL = 100 Kg - Weight: 8.53 Kg	
<b>CAV700A</b>	Double slot front cassette for 215x215mm accessories - Weight: 0.52 Kg	
<b>CAV700NA</b>	Single slot front holder for 254x254mm (10x10") accessories - Weight: 0.26 Kg	
<b>FCM100R</b>	Ø97mm 1/2 CTO correction filter (Rosco #3408) with holder	
<b>VD120</b>	120x120mm frosted glass	
<b>FRO/1017PD</b>	Heavy duty adjustable yoke - Weight: 4.33 Kg	
<b>FRO/SMEPD</b>	Heavy duty adjustable yoke equipped with TILT SpotMe sensor (E type)	
<b>G80</b>	Ø80mm horizontal chopper - Weight: 0.37 Kg	
<b>GR120</b>	Slot reducer for SGUP gobo holder (if PG80 option ) - Weight: 0.2 Kg	
<b>Kit G80</b>	Ø80mm chopper kit (G80+ GR120+ adaptation kit) - Weight: 0.69 Kg	
<b>M210TVCL</b>	Light shield for M210T push/pull colour changer - Weight: 1.98 Kg	
<b>BK/E1</b>	Extra weight kit for BK1 (0,5 Kg) - Weight: 0.5 Kg	
<b>BK1</b>	Followspot balancing kit (including 1 Kg counterweights) - Weight: 2.05 Kg	
<b>Kit TELRAD</b>	Telrad followspot sight with raiser and universal mounting kit - Weight: 1.23 Kg	

<b>SDUP</b>	Followspot cue sheet holder with universal mounting kit	
<b>TCSM</b>	SpotMe calibration tool kit	
<b>Maestro</b>	Maestro server for SpotMe - rackable unit: 1U - half 19" - Weight: 1.2 Kg	