

CRICKET - 1116B

ULTRA COMPACT - 1000 W TUNGSTEN



- **Type:** Followspot
- **Source:** 1000 W Tungsten - Convection cooling
- **Optics:** 10.5° to 22.5° zoom
- **Standard:** North american

Followspot

Anything else just isn't cricket!

The smallest of the followspot range with the optical excellence of its larger counterparts. Cricket's ultra compact dimensions and low power consumption make it the perfect introduction to Robert Juliat for discerning schools, amateur dramatics and smaller venues.

Features

- **Fully closing iris:** removable for fast, easy replacement
- **Universal gobo holder:** "A" size glass and metal gobo
- **Internal glass filter holder:** long term use of durable coloured, dichroic or textured glass
- **Colour changer:** 6-way, 'push/pull' colour changer system for simultaneous use of multiple filters
- **Easy focus reference:** graduated scale on side of the unit; fast and easy refocusing

Optical

- **SX optical system:** double condenser optics for exceptional optical quality
- **Variable zoom optics:** sharp focus at every beam angle. Independent control of image size and focus.

Construction

- **Made in France :** fully manufactured in Robert Juliat premises retaining complete control over all aspects of quality
- **Bodywork:** strong sheet metal construction for durability
- **Moving parts:** smooth at all times, even when hot
- **Captive knobs and handles:** additional security when working at height or in transit
- **Easy access to all parts:** easy cleaning, re-lamping and maintenance

Picture:1116A

DSEN088_1116B - 23/03/2022

Robert Juliat reserves the right to change or alter any of the items detailed on this page, to increase or improve manufacturing techniques without prior notice.

Robert Juliat S.A.S., 32 rue de Beaumont, 60530 Fresnoy-en-Thelle - France
Telephone : +33 (0)3 44 26 51 89 - fax : +33 (0)3 44 26 90 79 - info@robertjuliat.fr
www.robertjuliat.com



ROBERT JULIAT

Source



- **Lamp type:** Tungsten
- **Socket:** G22

Admissible lamps	Power *	Lumen output*	Colour temperature*	Life*
ANSI: EGT	1 000 W	28 500 lm	3200K	250 h

(*) manufacturer's data

Optics

Characteristics

- **Type:** Zoom
- **Beam range:** 10.5° to 22.5°
- **Focal length:** 189 - 408 mm

Gel filter

- **Shape:** Circle
- **Standard size:** 165 mm (6.5 in)

Gobo

- **Size:** A
- **Material:** Metal
Glass



Photometrics

with ANSI: BTR source

• Optics @ 10.5°

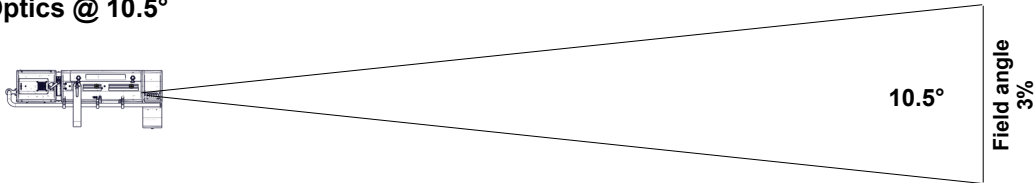

Beam intensity
281 000 cd

Distance	5 m	10 m	15 m	20 m	25 m	30 m
Diameter	0.9 m	1.8 m	2.8 m	3.7 m	4.6 m	5.5 m
Illumination	11 500 lux	2 850 lux	1 250 lux	710 lux	450 lux	320 lux
Distance	15 ft	35 ft	50 ft	65 ft	80 ft	100 ft
Diameter	2.8 ft	6.4 ft	9.2 ft	11.9 ft	14.7 ft	18.4 ft
Illumination	1 250 fc	230 fc	120 fc	70 fc	44 fc	29 fc

• Optics @ 22.5°

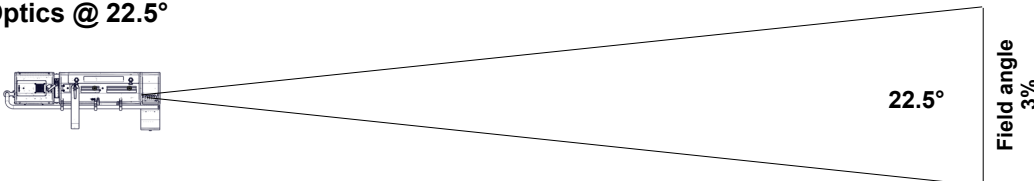

Beam intensity
13 300 cd

Distance	5 m	10 m	15 m	20 m	25 m	30 m
Diameter	2 m	4 m	6 m	8 m	9.9 m	11.9 m
Illumination	540 lux	140 lux	60 lux	34 lux	22 lux	15 lux
Distance	15 ft	35 ft	50 ft	65 ft	80 ft	100 ft
Diameter	6 ft	13.9 ft	19.9 ft	25.9 ft	31.8 ft	39.8 ft
Illumination	60 fc	11 fc	6 fc	4 fc	3 fc	2 fc

Dimensions and weight

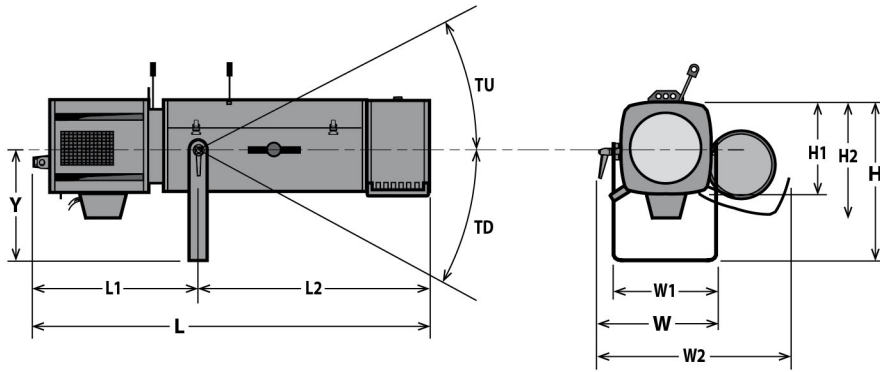

Weight: 16 kg (35.2 lbs)

Height	Length	Width	Yoke	Tilt
H= 390 mm (15.4 in)	L= 920 mm (36.2 in)	W= 330 mm (13 in)	Y= 283 mm (11.1 in)	TU= 45°
H1= 208 mm (8.2 in)	L1= 350 mm (13.8 in)	W1= 208 mm (8.2 in)		TD= 45°
H2= 265 mm (10.4 in)	L2= 570 mm (22.4 in)	W2= 490 mm (19.3 in)		

Shipping

- **Weight :** 18 kg (39.6 lbs)
- **Volume :** .16 m³ (5.65 ft³)

Installation

- **Minimum distance to illuminated surface:** 2.5 m (8.2 ft)
- **Operating position:**

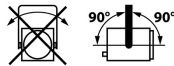

Warranty

- **Fixture: 2 years**
See General Sales Condition on website

Approvals



Construction

- **Housing:** Steel sheet - Aluminium
- **Colour:** Black
- **Cooling:** Convection cooling
- **Maximum ambient temperature (Ta):** 40°C (104°F)
- **Maximum case temperature (Tc):** 260°C (500°F)
- **Total heat dissipation:** 3 413 BTU/h
- **Ingress Protection (IP) rating:** IP20

Electrical compatibility

- 230/240 V - 50 Hz
- 115/120 V - 60 Hz

Power input



- **Type:** attached power cord
- **Cable:** 14 AWG SJ type (UL/CSA)
- **Length:** 1.5 m (4.9 ft)
- **Power connector:** without connector

Power consumption

Voltage	Frequency	Current	Power
120 V	60 Hz	9 A	1000 W















Model

1116B	1000 W Tungsten Followspot - G22 socket - 1116B Cricket - 10.5/22.5° - without fan - North american standard
--------------	--

Options

FC1124	Flight-case for Ultra Compact range / GT stand - Dim: 1210x600x560mm - Weight: 35 Kg	
---------------	--	---

Accessories

IS750	Full closing iris with holder - Poids: 0.35 Kg 1 included	
PF1114	Ø165 mm metal filter holder 6 included	
SGUX	Universal "A" size gobo-holder (metal, glass, frosted glass) 1 included	
M165TP	6 ways "push/pull" colour changer - Poids: 2.09 Kg 1 included	
GT1000	Tripod stand - SWL: 40 Kg - max. height: 1550 mm - Poids: 9.27 Kg	
GT800	Tripod stand - SWL: 40 Kg - max. height: 1550 mm - Poids: 7.98 Kg	
T1000	TV spigot with followspots swivel head - Poids: 1.82 Kg	
T4000	Followspot mount for Ø50mm pipe (suspension or overhead) - SWL= 100 Kg - Poids: 4.88 Kg	
CAV600A	Double slot front cassette for 180x180mm accessories - Poids: 0.43 Kg	
T/1650CDSXCW	SULLY 115W LED compartment with potentiometer and display - Cool White - North American standard - 1,50m UL/CSA power cable without plug - Poids: 2.33 Kg	
T/1650CDSXWW	SULLY 115W LED compartment with potentiometer and display - Warm White - North American standard - 1,50m UL/CSA power cable without plug - Poids: 2.33 Kg	
T/1650CSXCW	SULLY 115W LED compartment with potentiometer - Cool White - North American standard - 1,50m UL/CSA power cable without plug - Poids: 2.27 Kg	
T/1650CSXWW	SULLY 115W LED compartment with potentiometer - Warm White - North American standard - 1,50m UL/CSA power cable without plug - Poids: 2.27 Kg	
VD120	120x120mm frosted glass	
Kit TELRAD	Telrad followspot sight with raiser and universal mounting kit -	

Poids: 1.23 Kg



SDUP

Followspot cue sheet holder with universal mounting kit



FC1124/S

Flight-case for Ultra Compact range / GT stand - Poids: 35 Kg



W/GT800

Set of 3 wheels for GT800/1000 stand - Poids: 2.33 Kg

