



- **Type:** Profile spot
- **Source:** 1000/1200 W Tungsten
- **Optics:** 28° to 54° zoom
- **Standard:** North american

The classic 1/1.2K theatre zoom profile

The most versatile of the Juliat profiles, the short throw 613 SX is equally happy on-stage, overhead, on side booms or prosceniums. Its advanced functions and optical quality make this fixture indispensable in opera houses, theatres and studios.

Interchangeable lamp bases can be swapped with the Quincy range to give a choice of tungsten or discharge options.

Features

- **Multi-function double gate:** simultaneous use of gobos and iris. Sharp focus of both gobo and shutter
- **Shutter gate:** up to 8 shutters. Remove shutters for easy maintenance or tuck fully inside gate for secure transport
- **User-friendly shutter-lock system:** secures shutters' setting in any circumstances (locking efficient up to 4 shutters)
- **Universal gobo holder:** "A" size glass and metal gobo
- **Lens tube lock feature:** secures rotating lens tube against unwanted movement
- **90° rotating lens tube / gate / front accessories holder:** rotation of the projected image is always possible while the lamp remains vertical – no need to move the yoke
- **Internal glass filter holder:** long term use of durable coloured, dichroic or textured glass
- **Easy focus reference:** graduated scale on side of the unit; fast and easy refocusing
- **Tilt reference on hanging yoke:** index for rapid re-positioning

Optical

- **Factory set optical train:** no re-alignment even after lamp change
- **SX optical system:** double condenser optics for exceptional optical quality
- **Variable zoom optics:** sharp focus at every beam angle. Independent control of image size and focus. Focus handles on both sides

Construction

- **Made in France :** fully manufactured in Robert Juliat premises retaining complete control over all aspects of quality
- **Interchangeable lamp base:** with Sully (115W LED) series
- **Air vents:** efficient cooling with no light spill
- **Bodywork:** strong sheet metal construction for durability
- **Moving parts:** smooth at all times, even when hot
- **Captive knobs and handles:** additional security when working at height or in transit
- **Easy access to all parts:** easy cleaning, re-lamping and maintenance
- **Spare parts and accessories:** interchangeable across the tungsten, discharge or LED ranges, reducing running costs

Picture:613SX

DSEN043_613CSX - 23/03/2022

Robert Juliat reserves the right to change or alter any of the items detailed on this page, to increase or improve manufacturing techniques without prior notice.

Robert Juliat S.A.S., 32 rue de Beaumont, 60530 Fresnoy-en-Thelle - France
Telephone : +33 (0)3 44 26 51 89 - fax : +33 (0)3 44 26 90 79 - info@robertjuliat.fr
www.robertjuliat.com

Source



- **Lamp type:** Tungsten
- **Socket:** G22

Admissible lamps	Power *	Lumen output*	Colour temperature*	Life*
ANSI: EGT	1 000 W	28 500 lm	3200K	250 h

(*) manufacturer's data

Optics

Characteristics

- **Type:** Zoom
- **Beam range:** 28° to 54°
- **Focal length:** 79 - 160 mm

Gel filter

- **Shape:** Square
- **Standard size:** 191x191 mm (7.5x7.5 in)

Gobo

- **Size:** A
- **Material:** Metal
Glass



Front extension cassette for 215x215mm accessories recommended for dark colours

Photometrics

with LIF: CP70 - ANSI: FVA/FVB source

• Optics @ 28°

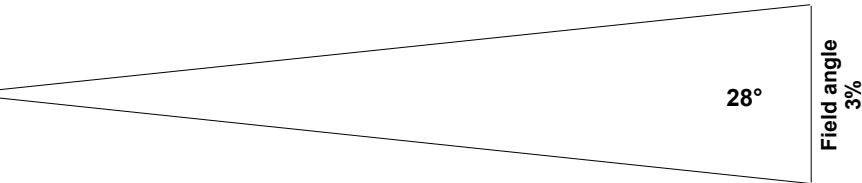
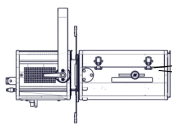

Beam intensity
63 000 cd

Distance	5 m	10 m	15 m	20 m	25 m	30 m
Diameter	2.5 m	5 m	7.5 m	10 m	12.5 m	15 m
Illumination	2 550 lux	640 lux	290 lux	160 lux	110 lux	75 lux
Distance	15 ft	35 ft	50 ft	65 ft	80 ft	100 ft
Diameter	7.5 ft	17.5 ft	24.9 ft	32.4 ft	39.9 ft	49.9 ft
Illumination	290 fc	55 fc	26 fc	15 fc	10 fc	7 fc

• Optics @ 54°

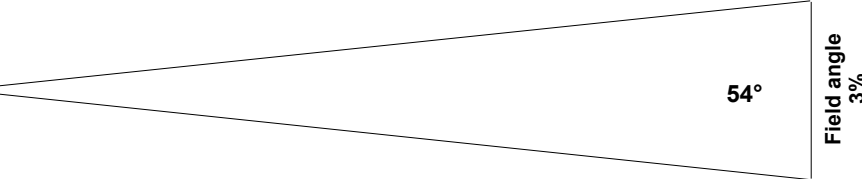
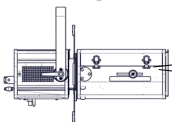

Beam intensity
20 000 cd

Distance	5 m	10 m	15 m	20 m	25 m	30 m
Diameter	5.1 m	10.2 m	15.3 m	20.4 m	25.5 m	30.6 m
Illumination	810 lux	210 lux	90 lux	51 lux	33 lux	23 lux
Distance	15 ft	35 ft	50 ft	65 ft	80 ft	100 ft
Diameter	15.3 ft	35.7 ft	51 ft	66.2 ft	81.5 ft	101.9 ft
Illumination	90 fc	17 fc	9 fc	5 fc	4 fc	3 fc

Dimensions and weight

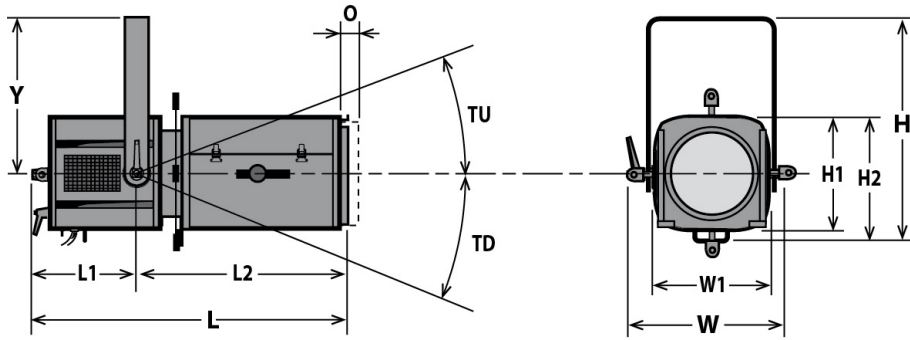

Weight: 11 kg (24.2 lbs)

Height	Length	Width	Yoke	Tilt	Option
H= 415 mm (16.3 in)	L= 565 mm (22.2 in)	W= 330 mm (13 in)	Y= 280 mm (11 in)	TU= TBD°	O= 25 mm (1 in)
H1= 208 mm (8.2 in)	L1= 250 mm (9.8 in)	W1= 208 mm (8.2 in)		TD= TBD°	
H2= 240 mm (9.4 in)	L2= 315 mm (12.4 in)				

Shipping

- **Weight :** 14.5 kg (31.9 lbs)
- **Volume :** .09 m³ (3.18 ft³)

Installation

- **Minimum distance to illuminated surface:** 1.5 m (4.9 ft)
- **Operating position:**



Construction

- **Housing:** Steel sheet - Aluminium
- **Colour:** Black
- **Cooling:** Convection cooling
- **Maximum ambient temperature (Ta):** 40°C (104°F)
- **Maximum case temperature (Tc):** 260°C (500°F)
- **Total heat dissipation:** 3 413 BTU/h
- **Ingress Protection (IP) rating:** IP20

Electrical compatibility

- 230/240 V - 50 Hz
- 115/120 V - 60 Hz

Power input



- **Type:** attached power cord
- **Cable:** 14 AWG SJ type (UL/CSA)
- **Length:** 1.5 m (4.9 ft)
- **Power connector:** without connector

Power consumption

Voltage	Frequency	Current	Power
120 V	60 Hz	9 A	1000 W

Warranty

- **Fixture: 2 years**
See General Sales Condition on website

Approvals









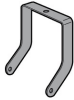





Model

613CSX	1000/1200 W Tungsten Profile spot - G22 socket - 613CSX - 28/54° - North american standard
---------------	--

Options

CAV600C	Double slot front cassette for 191x191mm (7-1/2") accessories	
FCD600PV	Angled yoke	

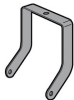
Accessories

D8	Shutter for SX series 4 included	
SGUX	Universal "A" size gobo-holder (metal, glass, frosted glass) 1 included	
IWSX755	Drop-in iris (monoplane) with holder - Poids: 0.26 Kg	
G500	180x180mm safety grid	
CAV600AC	Double slot front cassette for 191x191mm (7-1/2") accessories - Poids: 0.45 Kg	
APH 68LED	Double-condenser set for Led profile - Poids: 0.58 Kg	
T/650CDSXCW	SULLY 115W LED compartment with display - Cool White - North American standard - 1,50m UL/CSA power cable without plug - Poids: 2.33 Kg	
T/650CDSXWW	SULLY 115W LED compartment with display - Warm White - North American standard - 1,50m UL/CSA power cable without plug - Poids: 2.33 Kg	
T/650CSXCW	SULLY 115W LED compartment - Cool White - North American standard - 1,50m UL/CSA power cable without plug - Poids: 2.27 Kg	
T/650CSXWW	SULLY 115W LED compartment - Warm White - North American standard - 1,50m UL/CSA power cable without plug - Poids: 2.27 Kg	
VD120	120x120mm frosted glass	
FCD600	Angled yoke	
876	Hook clamp 40x10mm with 28mm M10 screw for Ø35 to 50mm pipes - SWL: 50Kg - Poids: 1.25 Kg	
880	Hook clamp 40x10mm with 28mm M10 screw for Ø50 to 63mm pipes - SWL: 50Kg - Poids: 1.36 Kg	

CS2

Safety cable Ø3 mm L= 600mm - SWL: 75 Kg

