

329CHPC

329 - 2000 W TUNGSTEN



- **Type:** Single lens luminaire
- **Source:** 2000 W Tungsten
- **Optics:** 200 mm Plano Convex lens
- **Standard:** North american

Single lens

The industry standard for 2K units

329H is a favourite in theatres, opera houses and concert halls the world over.

A G22 lamp socket holds the lamp securely in place giving increased reliability and longer lamp life. Ideal for medium to large venues and rental companies.

Features

- **Theatre front cassette:** no light spill to distract audiences or performers
- **Colour runners:** double runners to hold accessories and colour filters
- **Barn door:** unique rotating barn door with 4 individually rotating blades – makes even the most difficult angle possible
- **Focus adjustment:** smooth focus adjustment from front or rear, even when lantern is hot, for a longer lamp life
- **Tilt reference on hanging yoke:** index for rapid re-positioning

Optical

- **200 mm lens:** compact size 2 / 2.5 KW fixture

Construction

- **Made in France :** fully manufactured in Robert Juliat premises retaining complete control over all aspects of quality
- **Air vents:** efficient cooling with no light spill
- **Bodywork:** strong sheet metal construction for durability
- **Moving parts:** smooth at all times, even when hot
- **Captive knobs and handles:** additional security when working at height or in transit
- **Access:** easy access to lamp house and lenses through front opening for fast and efficient maintenance
- **Easy access to all parts:** easy cleaning, re-lamping and maintenance
- **Safety grid:** earthed safety grid fitted as standard
- **Safety first:** front accessories safety cable attachment point

Picture:329H

DSEN022_329CHPC - 13/09/2021

Robert Juliat reserves the right to change or alter any of the items detailed on this page, to increase or improve manufacturing techniques without prior notice.

Robert Juliat S.A.S., 32 rue de Beaumont, 60530 Fresnoy-en-Thelle - France
Telephone : +33 (0)3 44 26 51 89 - fax : +33 (0)3 44 26 90 79 - info@robertjuliat.fr
www.robertjuliat.com



ROBERT JULIAT

Source



- **Lamp type:** Tungsten
- **Socket:** G22

Admissible lamps	Power *	Lumen output*	Colour temperature*	Life*
LIF: CP92 - 120V - ANSI: CP92 -	2 000 W	55 000 lm	3200K	400 h

(*) manufacturer's data

Optics

Characteristics

- **Type:** Single lens
- **Beam range:** 16° to 72°
- **Lens:** 200 mm Plano Convex lens

Gel filter

- **Shape:** Square
- **Standard size:** 245x245 mm (9.6x9.6 in)

Photometrics

with LIF: CP92 source

• Optics @ 17°

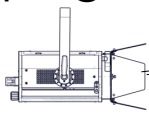

17°

Field angle
3%

Beam intensity
100 000 cd

Distance	5 m	10 m	15 m	20 m	25 m	30 m
Diameter	1.5 m	3 m	4.5 m	6 m	7.5 m	9 m
Illumination	4 050 lux	1 010 lux	450 lux	260 lux	170 lux	120 lux
Distance	15 ft	35 ft	50 ft	65 ft	80 ft	100 ft
Diameter	4.5 ft	10.5 ft	14.9 ft	19.4 ft	23.9 ft	29.9 ft
Illumination	450 fc	85 fc	41 fc	24 fc	16 fc	11 fc

Dimensions and weight

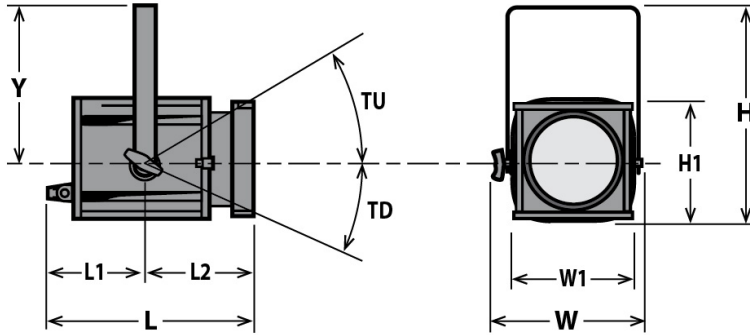

Weight: 14 kg (30.8 lbs)

Height	Length	Width	Yoke	Tilt
H= 520 mm (20.5 in)	L= 470 mm (18.5 in)	W= 410 mm (16.1 in)	Y= 345 mm (13.6 in)	TU= TBD°
H1= 320 mm (12.6 in)	L1= 285 mm (11.2 in) L2= 185 mm (7.3 in)	W1= 320 mm (12.6 in)		TD= TBD°

Shipping

- **Weight :** 16 kg (35.2 lbs)
- **Volume :** .09 m³ (3.18 ft³)

Installation

- **Minimum distance to illuminated surface:** 2.7 m (8.9 ft)
- **Operating position:**



Construction

- **Housing:** Steel sheet - Aluminium
- **Colour:** Black
- **Cooling:** Convection cooling
- **Maximum ambient temperature (Ta):** 40°C (104°F)
- **Maximum case temperature (Tc):** 250°C (482°F)
- **Total heat dissipation:** 6 826 BTU/h
- **Ingress Protection (IP) rating:** IP20

Electrical compatibility

- 230/240 V - 50 Hz
- 115/120 V - 60 Hz

Power input



- **Type:** attached power cord
- **Cable:** 12 AWG SJ type (UL/CSA)
- **Length:** 1.5 m (4.9 ft)
- **Power connector:** without connector

Power consumption

Voltage	Frequency	Current	Power
120 V	60 Hz	17 A	2000 W

Warranty

- **Fixture: 2 years**
See General Sales Condition on website

Approvals









Model

329CHPC

2000 W Tungsten Single lens luminaire - G22 socket - 200mm Plano Convex - 329CHPC - North american standard

Options

Accessories

PF329M	245x245mm metal filter holder - Poids: 0.23 Kg 1 included	
G329	245x245mm safety grid 1 included	
CF329	4 rotating leaves on a rotating barndoor - 245x245mm (without safety cable) - Poids: 1.42 Kg	
876	Hook clamp 40x10mm with 28mm M10 screw for Ø35 to 50mm pipes - SWL: 50Kg - Poids: 1.25 Kg	
880	Hook clamp 40x10mm with 28mm M10 screw for Ø50 to 63mm pipes - SWL: 50Kg - Poids: 1.36 Kg	
CS2	Safety cable Ø3 mm L= 600mm - SWL: 75 Kg	
CS5	Safety cable Ø1,5 mm L=300mm for front accessory with karabiner and quick link - SWL: 25 Kg	