

# CIN'K - 312CLF

CIN'K - 1200 W HID

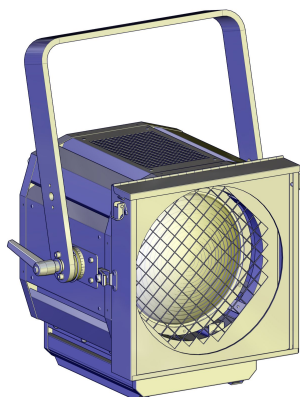

- **Type:** Single lens luminaire
- **Source:** 1200 W HID
- **PSU:** Magnetic
- **Optics:** 250 mm Fresnel lens
- **Standard:** 110 V North american

Single lens

## Powerful discharge unit for theatres and more

Cin'k's cool colour temperature is perfect for ballet and daylight effects. Its 250 mm lens ensures powerful output while the theatre-inspired front cassette provides an efficient colour filter holder with no light spill. Smooth dimming is possible with a Jalousie 2 digital dimmer.

### Features

- **Jalousie 2:** optional DMX-controlled digital shutter for the dimming of discharge units
- **Theatre front cassette:** no light spill to distract audiences or performers
- **Colour runners:** double runners to hold accessories and colour filters
- **Focus reference:** index for easy focus reference
- **Tilt reference on hanging yoke:** index for rapid re-positioning

### Optical

- **250 mm lens:** light output equivalent to 'studio' 300 mm fixtures

### Construction

- **Made in France :** fully manufactured in Robert Juliat premises retaining complete control over all aspects of quality
- **Separate PSU:** compact for easy handling and rapid maintenance
- **Bodywork:** strong sheet metal construction for durability
- **Moving parts:** smooth at all times, even when hot
- **Captive knobs and handles:** additional security when working at height or in transit
- **Access:** easy access to lamp house and lenses through front opening for fast and efficient maintenance
- **Easy access to all parts:** easy cleaning, re-lamping and maintenance
- **Removable assemblies:** fast-plug cable connectors and complete component assemblies (mirror, condenser set and lamp house assembly) save maintenance and cleaning time
- **Specially designed handle:** for fast cable changing without having to go inside the unit
- **Safety grid:** earthed safety grid fitted as standard
- **Safety first:** front accessories safety cable attachment point

Picture:312LF

DSEN012\_312CLF - 07/01/2020

Robert Juliat reserves the right to change or alter any of the items detailed on this page, to increase or improve manufacturing techniques without prior notice.

Robert Juliat S.A.S., 32 rue de Beaumont, 60530 Fresnoy-en-Thelle - France  
Telephone : +33 (0)3 44 26 51 89 - fax : +33 (0)3 44 26 90 79 - info@robertjuliat.fr  
www.robertjuliat.com



ROBERT JULIAT

## Source



- **Lamp type:** Discharge
- **Power:** 1200 W
- **Socket:** G22
- **Hot re-strike:** no

Admissible lamps	Power *	Lumen output*	Colour temperature*	Life*	CRI* (min)
MSD 1200W (Philips )	1 200 W	92 000 lm	6000K	3 000 h	80
MSR 1200W (Philips )	1 200 W	110 000 lm	5900K	800 h	95
MSR 1200W/2 (Philips )	1 200 W	110 000 lm	7200K	800 h	85
CSR 1200W/2 SE (GE )	1 200 W	110 000 lm	7200K	800 h	75

(\*) manufacturer's data

## Optics

### Characteristics

- **Type:** Single lens
- **Beam range:** 6° to 53°
- **Lens:** 250 mm Fresnel lens

### Gel filter

- **Shape:** Square
- **Standard size:** 333x333 mm (13.1x13.1 in)

## Photometrics

with MSD 1200W (Philips ) source

### • Optics @ 6°

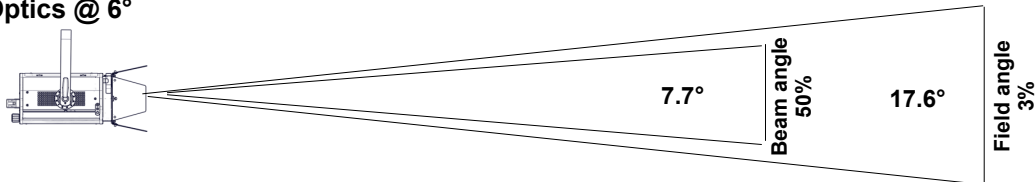

**Beam intensity**  
373 400 cd

<b>Distance</b>	5 m	10 m	15 m	20 m	25 m	30 m
<b>Diameter</b>	1.5 m	3.1 m	4.6 m	6.2 m	7.7 m	9.3 m
<b>Illumination</b>	15 000 lux	3 750 lux	1 700 lux	940 lux	600 lux	420 lux
<b>Distance</b>	15 ft	35 ft	50 ft	65 ft	80 ft	100 ft
<b>Diameter</b>	4.6 ft	10.8 ft	15.5 ft	20.1 ft	24.8 ft	31 ft
<b>Illumination</b>	1 700 fc	310 fc	150 fc	90 fc	60 fc	38 fc

### • Optics @ 53°

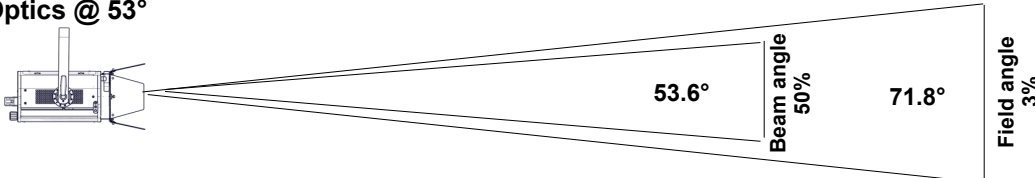

**Beam intensity**  
45 800 cd

<b>Distance</b>	5 m	10 m	15 m	20 m	25 m	30 m
<b>Diameter</b>	7.2 m	14.5 m	21.7 m	29 m	36.2 m	43.4 m
<b>Illumination</b>	1 850 lux	460 lux	210 lux	120 lux	75 lux	55 lux
<b>Distance</b>	15 ft	35 ft	50 ft	65 ft	80 ft	100 ft
<b>Diameter</b>	21.7 ft	50.7 ft	72.4 ft	94.1 ft	115.8 ft	144.8 ft
<b>Illumination</b>	210 fc	38 fc	19 fc	11 fc	8 fc	5 fc

## Dimensions and weight

### Unit

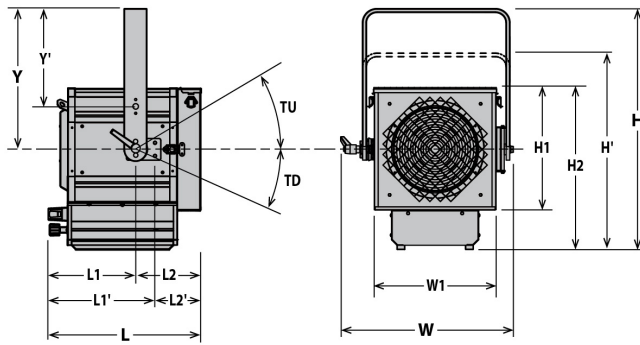

**Weight:** 16 kg (35.2 lbs)

Height	Length	Width	Yoke	Tilt
H= 510 mm (20.1 in)	L= 425 mm (16.7 in)	W= 465 mm (18.3 in)	Y= 270 mm (10.6 in)	TU= TBD°
H'= 630 mm (24.8 in)	L1= 250 mm (9.8 in)	W1= TBD mm (0 in)	Y'= 390 mm (15.4 in)	TD= TBD°
H1= TBD mm (0 in)	L1'= 290 mm (11.4 in)			
H2= 410 mm (16.1 in)	L2= TBD mm (0 in)			

### Shipping

- **Weight :** Unit: 20 kg (74.4 lbs)  
PSU: 33.8 kg (74.4 lbs)
- **Volume :** Unit: .14 m<sup>3</sup> (4.94 ft<sup>3</sup>)  
PSU: .05 m<sup>3</sup> (1.77 ft<sup>3</sup>)

### PSU

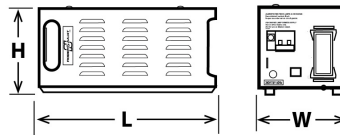

- Width:** W= 185 mm (7.3 in)
- Height:** H= 200 mm (7.9 in)
- Length:** L= 590 mm (23.2 in)
- Weight:** 33 Kg (72.6 lbs)

### Installation

- **Minimum distance to illuminated surface:** 2.7 m ( 8.9 ft )
- **Operating position:**

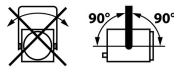

### Warranty

- **Fixture: 2 years**  
See General Sales Condition on website

### Approvals



### Construction

- **Housing:** Steel sheet - Aluminium
- **Colour:** Black
- **Cooling:** Convection cooling
- **Maximum ambient temperature (Ta):** 40°C (104°F)
- **Maximum case temperature (Tc):** 240°C (464°F)
- **Total heat dissipation:** 5 802 BTU/h
- **Protection rating:** 20

- **PSU housing:** Steel sheet - Aluminium
- **PSU colour:** Black
- **PSU cooling:** Convection cooling
- **PSU maximum ambient temperature (Ta):** 40°C (104°F)
- **PSU maximum case temperature (Tc):** 70°C (158°F)

### Electrical compatibility

- 220/230 V - 50 Hz
- 245 V - 50 Hz
- 110/120 V - 60 Hz
- 208 V - 60 Hz
- 220/230 V - 60 Hz
- 100 V - 50 Hz
- 100 V - 60 Hz
- Selector: local switch

### Power input



- **Type:** attached power cord
- **Cable:** 12 AWG SJ type (UL/CSA)
- **Length:** 1,5 m (4,9 ft)
- **Power connector:** without connector

### Power consumption

Voltage	Frequency	Current	Power	Power factor
110 V	60 Hz		1700 W	TBD

### Power Supply Unit

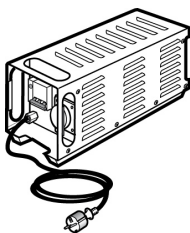

- **PSU:** Separate - Magnetic PSU
- **Lighting unit / PSU cable:** Cable attached to unit - length: 3 m (9,8 ft)  
Type: 3G4 EWKF with 16A black 3P+E 7h IEC60309 connector
- **Maximum distance between lighting unit and PSU:** 25 m (82 ft)
- **Control:** Local
- **Protection:** Mains: 25A 2P2D - C curve breaker - UL / Electronic: 1A 1P1D - C curve breaker - UL











## Model

**312CLF**

1200 W HID Single lens luminaire - 250mm Fresnel - 312CLF Cin'k - Magnetic PSU - 110V North american standard

## Options

## Accessories

<b>PF325</b>	333x333mm metal filter holder - Weight: ,52 Kg <b>1 included</b>	
<b>G325L</b>	333x333mm safety grid - Weight: ,44 Kg <b>1 included</b>	
<b>MSD 1200W</b>	MSD 1200W - Philips G22 1200W 3000h 6000K lamp	
<b>PFR325</b>	600x600 mm extended metal filter holder with 4 clips - Weight: 1,11 Kg	
<b>CF325</b>	4 rotating leaves on a rotating barndoor - 333x333mm (without safety cable) - Weight: 2,11 Kg	
<b>PFR CF325</b>	Extended filter holder and rotating barndoor set - 333x333mm	
<b>JAL2/280 A1</b>	Ø280mm Jalousie2 dimming shutter with adaptation for Cin'k series - Weight: 4,6 Kg	
<b>JAL2/340 A1</b>	Ø340mm Jalousie2 dimming shutter with adaptation for Cin'k series - Weight: 5,7 Kg	
<b>876</b>	Hook clamp 40x10mm with 28mm M10 screw for Ø35 to 50mm pipes - SWL: 50Kg - Weight: 1,25 Kg	
<b>880</b>	Hook clamp 40x10mm with 28mm M10 screw for Ø50 to 63mm pipes - SWL: 50Kg - Weight: 1,36 Kg	
<b>CS2</b>	Safety cable Ø3 mm L= 600mm - SWL: 75 Kg	